

The E-terminals manual

Foreword

This manual is a programming and function description for the operator terminals in the E-series, except E900, E900 VT and E910, and the programming software MAC Programmer+.

In the manual we assume that a PLC system from Mitsubishi Electric is connected to the terminal. When using other PLC brands we refer to the respective driver manual for PLC specific details. The functions in the terminals are the same, regardless of terminal used.

©G & L Beijer Electronics AB 2000, MA00351B, 2000-05

All examples in this manual are used solely to promote understanding of how the equipment works and its operation. G & L Beijer Electronics AB take no responsibility if these examples are used in real applications.

Because of the great many application areas for this equipment, the user himself must acquire the appropriate knowledge needed to use the equipment correctly for particular applications.

G & L Beijer Electronics AB absolves itself of all responsibilities for damage and injuries that may occur during installation or use of this equipment.
G & L Beijer Electronics AB absolves itself of all responsibilities for any type of modification made to the equipment.

If you have any comment or recommendations about the manual, please fill out this form to help us improve. Send or fax this page, or a copy of it to our address below.

Comment on the E-series manual	Page

Name

Company.....

Address

City, Zip code

Country

Telephone... ..Telefax.....

E-mail

Fax to the Marketing department, G & L Beijer Electronics AB, +46 40 93 23 01 or send it by mail to Marketing department, G & L BeijerElectronics AB, Box 74, SE-201 20 MALMÖ.

Safety precautions

General

- Check the delivery for transport damage. If damage is found, advise your supplier.
- The product fulfils the requirements of article 4 of EMC directive 89/336/EEC.
- Do not use the product in an explosive environment.
- Modifications, changes and additions to the product are forbidden.
- Use only spare parts approved by the manufacture.
- Read the user instructions carefully before use.
- This equipment should only be operated by qualified personnel.

At installation

- The product is constructed for stationary installation.
- Install the product according to the accompanying installation instructions.
- The product must be grounded according to the accompanying installation instructions.
- This equipment must be installed by qualified personnel.
- High voltage-, signal- and supply cables must be separated.
- The product should not be mounted in direct sunlight.

In use

- Keep the equipment clean.
- Emergency stop- and other safety functions should not be controlled from the terminal.
- Do not touch the keys, displays, etc. with sharp objects.

Service and maintenance

- The agreed guarantee applies.
- Clean the display and face with a soft cloth and mild detergent.
- Repairs should be made by qualified personnel.

At disassembly and scrapping

- Local regulations apply concerning recycling of products or part.
- Please note that the electrolyte condenser and display contain hazardous substances.

Contents

1 Introduction	1
1.1 Programming	3
1.2 Benefits of connecting to the PLC system.....	4
1.3 Status display and control	4
1.4 Location of the terminal	5
1.5 Compact solutions	6
2 Installation of the softwares	7
2.1 MAC Programmer+	7
2.2 Connecting the terminal to a personal computer	9
2.3 Down-loading the system program.....	9
3 Terminal functions	11
3.1 The operation modes, RUN, PROG and SETUP.....	11
3.2 The terminal's keyboard	16
3.3 Set the real time clock	20
3.4 Information page.....	21
3.5 "Joystick" function.....	22
4 General	25
4.1 Method for programming a project	25
4.2 Efficient communication	26
4.3 Menu structure.....	29
4.4 Blocks	30
4.5 Signal types in MELSEC	31
4.6 Signal format.....	33
5 Programming using MAC Programmer+	35
5.1 Creating a project.....	35
5.2 Changing project settings	38
5.3 Creating a block via the Block Manager	39
5.4 Programming blocks.....	46

5.5 The graphic block editor.....	47
5.6 The text block editor.....	57
5.7 The symbol manager.....	59
5.8 I/O change.....	62
5.9 Change BDTP station.....	63
5.10 I/O crossreference.....	64
5.11 Other editors.....	65
5.12 The File Menu.....	66
5.13 The Edit Menu.....	67
5.14 The View Menu.....	67
5.15 The Functions Menu.....	70
5.16 The Setup Menu.....	72
5.17 The Block Manager Menu.....	84
5.18 The Transfer Menu.....	84
5.19 The Window Menu.....	85
5.20 The Help Menu.....	86

**Not E50,
E100,
E200**

6 Graphic presentation and maneuvering.....	87
6.1 General parameters.....	87
6.2 Graphic objects.....	88
6.3 Maneuvering Graphic Blocks.....	118
6.4 Using the touch screen.....	121

7 Text-based presentation and maneuvering.....	127
7.1 General parameters.....	127
7.2 Text object.....	128
7.3 Maneuvering Textblocks.....	137

**Not E50,
E100,
E200**

8 Trends.....	139
8.1 Historical trends.....	139
8.2 Real-time trends.....	141
8.3 Defining trend objects.....	142
8.4 Transferring historical trend data.....	144

Not E50

9 Message library.....	147
-------------------------------	------------

Not E50, E100	10 Alarm handling	151
	10.1 Alarm grouping	151
	10.2 Alarm messages	153
	10.3 Configuring the alarm list.....	154
	10.4 Alarms in run-time mode.....	156
	10.5 Graphic alarm page in run-time mode	157
Not E50	11 Recipes	159
	11.1 Calculate the recipe size	160
	11.2 Creating a recipe with the terminal	161
	11.3 Transferring a recipe to the PLC system.....	162
	11.4 Erasing a recipe	162
	11.5 Using recipes in a personal computer.....	163
	11.6 Loading and saving recipes via the PLC program	164
Not E50	12 Passwords	167
	12.1 Defining security levels.....	167
	12.2 Defining passwords	167
	12.3 Logging in	169
	12.4 Password for transfer	169
	12.5 Password for all terminal functions.....	169
	12.6 Altering passwords in run-time mode.....	169
Not E50	13 Report print-outs	171
	13.1 Connection to a printer	172
	13.2 Text block printouts	172
	13.3 Graphic block printout.....	173
	13.4 Defining the print-out	173
	13.5 Printer settings	174
	13.6 Setting a communication port.....	175
	13.7 Control codes to printer	176
Not E50	14 Time control	177
	14.1 Defining the time channels	177
	14.2 Presentation in run-time mode	178

Only E700	15 System monitor	179
	16 Index addressing	181
	17 Communication	185
	17.1 Transparent mode	185
	17.2 The terminal as communication interface (No protocol mode)	189
	17.3 Modem connection	197
Not E50, E100, E200	18 Network communication	201
	18.1 Examples of possible networks	202
	18.2 Network communication via ETHERNET	211
	18.3 Serial network communication.....	216
	18.4 Network services	228
	18.5 Network accounts.....	242
Not E50, E100, E200	19 Network functions in the terminal	243
	19.1 FTP server	243
	19.2 SMTP client.....	246
	19.3 Terminal reflection – applet.....	247
	19.4 Web server	248
	19.5 Recommendations and limitations for network communication.....	258
Not E50, E100	20 LEDs	261
	21 Function keys	263
	21.1 Definitions	267
	21.2 Jump to block with the function keys.....	270

**Not E50,
E100,
E200**

22 Expansions card	271
22.1 IFC PBDP	271
22.2 IFC MC	271
22.3 IFC 128E	271
22.4 IFC ETTP and IFC ETCX.....	271
22.5 IFC PI.....	272
23 Project transfer	273
23.1 Terminal settings.....	274
23.2 Transfer settings	274
23.3 TCP/IP transfer.....	278
23.4 Serial transfer	279
23.5 Transfer via modem	279
24 Technical data	285
24.1 Membrane keyboard	292
24.2 Drawings	295
24.3 Character tables.....	310
25 Appendix	317
Index	I

1 Introduction

The pace of production in today's industrial work environment increases steadily. At the same time, the operator's job responsibilities increase and become more comprehensive. Quickly and simply, the operator must get machine status information and, equally simply, must be able to control the machine's operation. The controller's functions increase and become more advanced, making it possible to effectively and efficiently control complicated processes. With the *operator terminal* from G & L Beijer Electronics AB, *human-machine* communication is made simple and safe – even for the most advanced processes.

The graphical operator panels were developed to meet the requirements of human-machine communication for supervision and control in a variety of usage areas in the manufacturing- and process industries, etc. The terminal simplifies the operator's work because it is easily adapted to the operator's work environment. This means that the operator can continue to use the terms and protocols he or she is familiar with.

In the terminal, *projects* can be built up as *menu hierarchies*, or as *sequences*. A menu hierarchy comprises a main screen (with, for example, an overview) and a number of subsequent screens with more detailed information for a particular section. The operator can select which screen is displayed.

In the operator terminal, a screen is called a *block*.

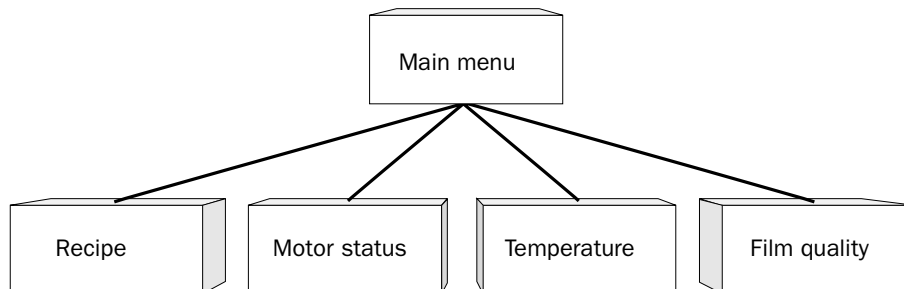

A sequence starts with a main menu, from which the operator chooses a sequence where the blocks are displayed in a pre-set arrangement. Normally, the blocks are controlled by the PLC program.

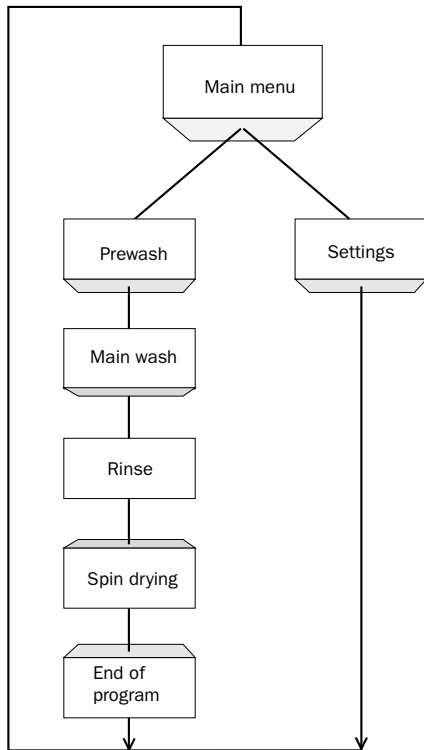

The terminal's functions enable either graphical or alphanumeric *presentation* and *control*. Additionally, there are functions for *alarm handling*, *printouts*, *trends*, *recipe handling*, *time control*, and more.

The terminal's functions are not only simple to manage, they also provide clear cost advantages compared to conventional systems with buttons, indicator lamps, time relays, preset counters, and seven-day clocks. The terminal also offers functions which facilitate a more comprehensive use of the PLC system.

1.1 Programming

The terminal is programmed through a PC using the *MAC Programmer+* software. It is also possible to program the terminal through the built-in keyboard. E710 is a terminal with a touch screen and has no built-in keyboard which means that the E710 must be programmed using the PC software.

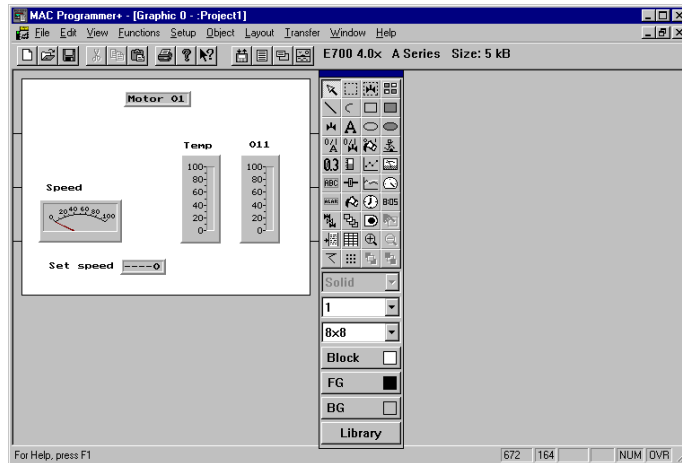

The terminal is *object oriented*, that is its work is based on an object, and the functions this is to have are determined afterwards. All types of signals are defined on this principle.

The programmed project is stored in the terminal.

1.2 Benefits of connecting to the PLC system

A terminal couple to the PLC system offers many benefits: the user doesn't need to make changes or additions to existing PLC programs; the terminal doesn't block any of the PLC system's inputs or outputs; and it improves the clarity and accessibility of such PLC system functions as time control and alarm handling.

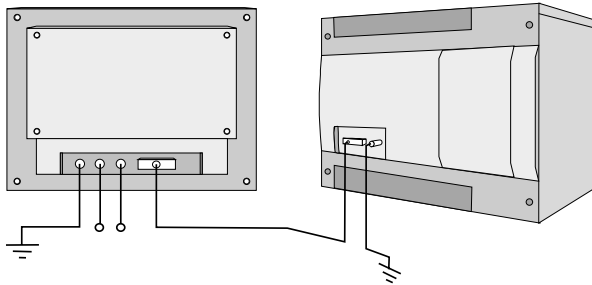

1.3 Status display and control

The operator is very familiar with indicator lamps, as well as analog and digital displays for showing status as they appear today in the vast majority of applications. The same applies to push buttons, rotary and thumb-wheel switches for controlling a system. Replacing them with a terminal provides the operator with all status display and control systems in one unit.

The operator can see and control all the information in the PLC system using the nomenclature of the machine. By doing so the operation of the complete system is not only enhanced but also simplified.

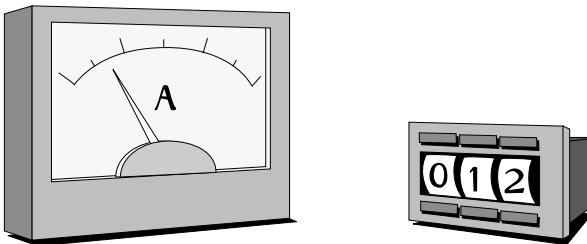

This is possible with a terminal thanks to the fact that the interchange of all information takes place through so-called blocks in the terminal. A block can be defined as a Textblock with only text information, or a Graphic block with full graphics if the terminal supports graphic.

The terminals have function keys for direct control. When an operator presses/energizes a function key during run, the command linked to the function key will be activated.

If several blocks are used, the operator can use jump objects to move between different blocks. In this way, a menu tree is created, allowing a structured application.

1.4 Location of the terminal

The terminal should be located close to the machine, to have maximum usability. The operator then receives the correct information directly and can react quickly and efficiently.

In some cases, such as monitoring/running or maintenance, the operator's workplace can be several kilometres from the process. Communication is via modem.

Several terminals can be installed, if the production line is long with a large number of work stations. A unit working in parallel can also be connected. This could be another terminal.

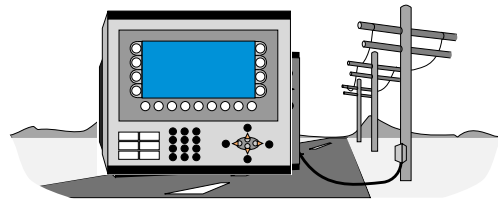
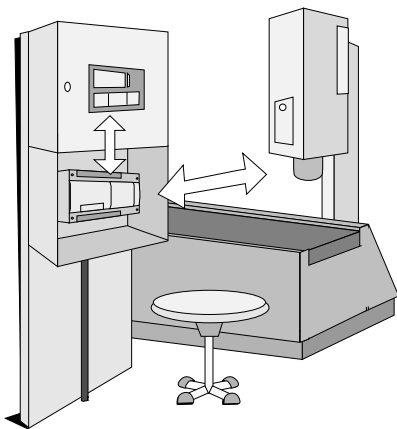

1.5 Compact solutions

External units such as barcode readers, weighing machines, telephone modems and so on can be connected to the PLC system via the terminal. All the connection requires is that the unit can be connected to an RS-232 interface and that the communications is by ASCII-protocol. Data entering the terminal is written directly to the PLC register.

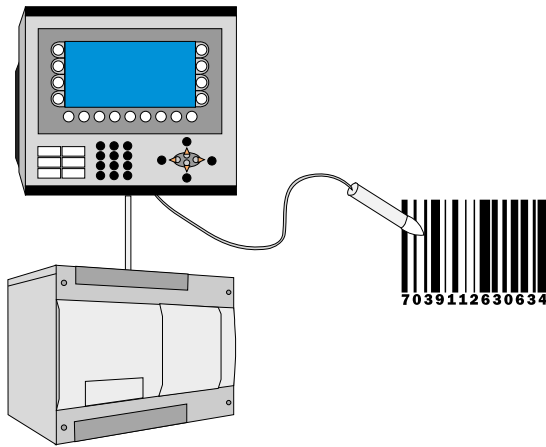

2 Installation of the softwares

2.1 MAC Programmer+

MAC Programmer+ is a program package used to develop projects for operator terminals from G & L Beijer Electronics AB. The functions in the MAC Programmer+ depend on selected terminal.

We recommend you to use the mouse when using the MAC Programmer+. For short commands we refer to the Windows User's Guide.

In the MAC Programmer+ you create your project with graphic blocks and text blocks and then transfer them to the terminal. The programming procedure is described in the chapter *Programming via MAC Programmer+*.

Help texts are available for all functions. By pressing the F1 key you will get assistance for the current function. You can also press the help button in the toolbar and the shape of the cursor changes, then click on the function you want information about.

System requirements

MAC Programmer+ should be running on a computer with 30 Mbytes of free space and Microsoft Windows 95/98/NT/2000. The MAC Programmer+ can be used with either colour or monochrome monitors.

Installing the MAC Programmer+

The MAC Programmer+ is supplied on a CD. Place the CD in your CD ROM drive and the setup of the programs will start automatically. If not, call up **RUN** from the **Start** menu and type D:\setup.exe (assuming D: is your CD drive name). Choose to install MAC Programmer+ by clicking on the name and follow the instructions.

The setup will create an icon to MAC Programmer+ and the manual in the MAC Programmer+ group. You will find MAC Programmer+ and the manual by clicking on Start and choosing Program/MAC Programmer+. The manual can also be read directly from the CD by clicking on Manuals.

The menu bar

The menu bar contains a number of pull down menus; **File, Edit, View, Functions, Setup, Object, Transfer, Windows** and **Help**. The File menu contains functions which affect the whole project. In the Edit menu you find functions for cut, copy and paste. The View menu contains the different editors, such as the **block editor** and **symbol manager**. In the menu **Functions** LEDs, passwords etc are defined. The basic settings for the terminals are made in the Setup menu. The Object menu is only available in the editors and contains all the objects. The objects can also be found in the toolbox. The menu Transfer is used for transferring projects between the MAC Programmer+ and the terminal. In the Windows menu you will find the windows functions e.g. zoom in/out, show/hide the toolbox, status bar etc. Furthermore you make the grid settings and state the path to a external program e.g. Paint. In the Help menu you will find help functions for the program.

The status bar

The status bar is displayed at the bottom of the MAC Programmer+ window. To display or hide the status bar, use the Status Bar command in the Window menu.

The left area of the status bar describes actions of menu items as you use the arrow keys to navigate through menus. This area similarly shows messages that describe the actions of the toolbox button that the cursor point at.

The right areas of the status bar indicate which of the following keys are locked on:

OVR Overwrite (Insert key)

CAP The Caps Lock

NUM The Num Lock

Coordinates, line and column, in block editor are also displayed.



2.2 Connecting the terminal to a personal computer

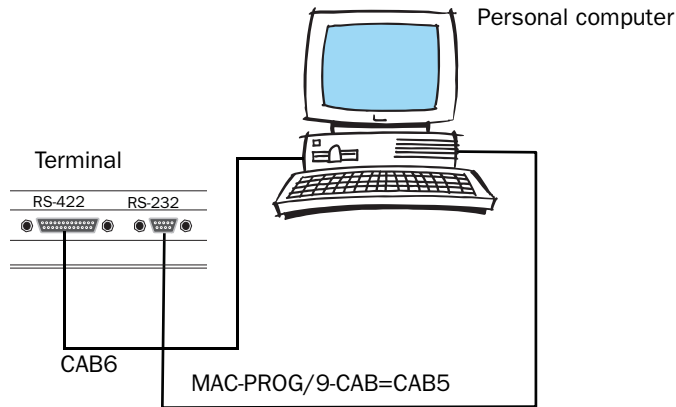

Use the cable recommended in the driver manual for the selected PLC system for connection to the terminal.

Note!

The power should be switched off during the connecting procedure.

2.3 Down-loading the system program

Not valid for E50.

The terminal has a system program (operative system) which is stored in the terminal's memory when delivered. The system program can be exchanged, for example when updating to newer versions. The following is required to transfer the system program to the terminal:

- Personal computer
- Transfer cable between the PC and the E-terminal
- The System Loader personal computer program (available as an icon in the program group HMI Tools). See the HMI Tools manual for installation of the program group.
- File with the new system program (e.g. E700V403.BIN).

Note!

All communication between the personal computer and the operator terminal E50 takes place via the programming tool MAC Programmer+. The system program is transferred at the same time as the driver. See the chapter Project transfer. The personal computer programs in the program group HMI Tools can not be used with E50.

Transfer in the following steps:

1. Connect the cable between the personal computer and the terminal.
2. On the E-terminal you hold the [←] and [F1] keys pressed on start up, when the main cable (voltage feed) is connected, to set the terminal in sysload position. On the touch terminal E710 press [F1] + [F2] + [F8] on start up. A LED should then blink green and the screen should be off.
3. The personal computer program is started by selecting Program/HMI Tools/Sysload in the Start menu.

No settings need to be made on the E-terminal.

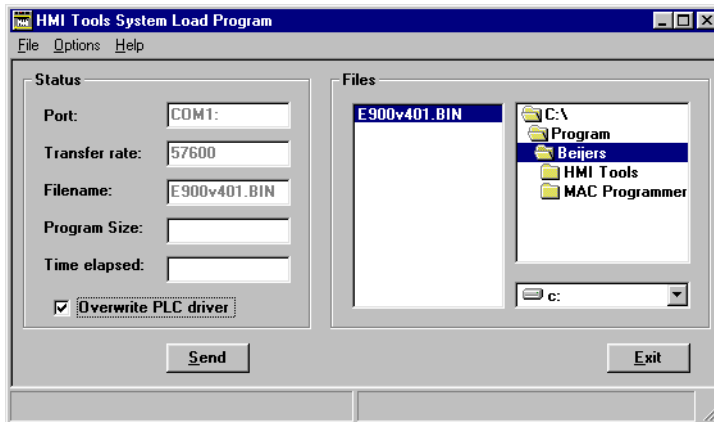

Under **Options, Settings** you set the communication port and transfer speed for the communication.

Down-loading of the system program can also take place through a modem for remote updating of terminals. Then the baudrate must be 2400 baud.

Note!

When downgrading a terminal it is important to make sure that the square “Overwrite PLC driver” is marked.

3 Terminal functions

This chapter describes the different modes in the terminal, the keyboard and the information page in the terminal. Description of the different key sequences can be found in the section “Key sequences”

3.1 The operation modes, RUN, PROG and SETUP

The E-terminal has three operating modes. E50 has only Run-time mode and transfer mode.

- *SETUP mode*, where the basic settings are made such as choice of PLC system, menu language and printer settings.
- *Programming mode*, where the terminal can be programmed and changes can be easily made at system set-up.
- *Run-time mode*, when the terminal is running with PLC.

Switching between modes

Switch between PROG and RUN

Switch between programming, PROG, and run-time, RUN, by simultaneously pressing the [←] and [MAIN]. The possibility to switch between PROG and RUN from the terminal can be controlled via a password. For more information we refer to the chapter *Programming using MAC Programmer+*.

Switch between PROG and SETUP

To switch from PROG to SETUP you press [LEAVE] until the start-up menu is displayed, then press any key. Press [LEAVE] to return to PROG.

Switch between RUN and SETUP

Press [←] and [MAIN] simultaneously to enter programming mode, PROG. Then press any key when the start-up menu is displayed to enter the SETUP mode. To switch from SETUP mode to RUN you press [←] and [MAIN]. The following key sequences are equivalent to the key sequence [←] + [MAIN]:

E100 [←] + [ENTER]
E710 [F1] + [F2] + [F4]

The SETUP mode

In this section we describe functions that cannot be made via MAC Programmer+. For settings via MAC Programmer+ we refer to the chapter *Programming using the MAC Programmer+*.

Erasing the memory

In the SETUP menu in the terminal you will find the function **Erase memory**. The function erase the terminal's application memory. All blocks and definitions of alarms, time channels, function keys and system signals are erased.

Parameter	Description
Enter	The memory is erased. The configuration menu is shown automatically when the erasure is completed.
Prev	Return to the previous level without erasing the memory.

Note!

All data stored in the terminal is lost when the memory is erased. The language parameter are not affected by this function. Other parameters are erased or allocated the default setting values.

Memcard maintenance

Not valid for E50, E100 and E200.

Under **Memcard maintenance** you select to format a installed PCMCIA memory card or to transfer to and from the memory card. You can format the memory card as a backup card or as an expansion card. Under **Mem-Card** transfer you select to transfer: project to memcard, project from memcard, delete memcard project, recipe to memcard, recipe from memcard and delete memcard recipes. For more information see the manual for IFC MC.

Contrast setting

Not valid for E50, E100 and E200.

The contrast settings can be made in setup mode in the menu **Setup, Contrast settings** or in run-time mode via a jump to the system block 997. Pressing the function key marked + makes the display brighter and pressing the function key marked - makes the display darker. Return to previous level by pressing EXIT.

The Prog mode

The programming mode is the mode where the application can be modified. It is here you can change text- and graphic blocks, modify the time channels, alarms, recipes and function keys. We recommend that the terminal is programmed using the software MAC Programmer+.

Note!

Block 0 must be defined in the project in order to be able to run the application.

Edit

Editing graphic objects

The arrow keys are used when editing a graphic object to change the size of or move the object in 8-pixel steps. Changing/moving pixelwise is done by pressing [SNAP OFF] in the help line.

To move stepwise through all the objects in the editing mode press the [SELECT] key followed by [NEXTOBJ] in the help line. The object marked is inverted and the object type is shown in a square.

When an object is marked press [EDITOBJ] to edit the object's parameters, [DELOBJ] to erase the object and [LEAVE] to return. Point to an object and press [MOVE] or [SIZE] and make the changes with the arrow keys to move or change the size of the object.

Editing text objects

Mark an object by moving the cursor to the object with the arrow keys and press [Next] in the help line. You can scroll the text with the arrow keys if the Text-block holds more information than can be shown on the display. Press [LEAVE] in the help line to exit from a menu.

Help line

There is a help line in the terminal which contains functions linked to the function keys located directly under the line. The functions of the keys changes depending on which level is active. The help lines are only shown in the programming mode.

Function	Description
NEXT	Used to go to the next level. Settings made are saved.
LEAVE	Return to the previous level.
TOGGLE	Switch alternately.
LIST	Show option list.
INSERT	Insert.
DELETE	Delete.
HELP OFF	Switch between showing and removing help line.
SELECT	Mark an object.
SNAP OFF/ON	SNAP ON means moving and size change in 8-pixel steps. OFF = 1-pixel steps.
NEWOBJ	Create a new object.
PREVOBJ	Show previous object.
NEXTOBJ	Show the next object.

Function	Description
EDITOBJ	Edit an object.
DELOBJ	Delete an object.
MOVE	Move an object.
SIZE	Change the size of an object.
ENLARGE	Increase the character size in an object.
REDUCE	Decrease the character size in an object.

Transfer

Here you manually put the terminal in transfer mode. When the terminal is in transfer mode it is possible to transfer project between the terminal and the MAC Programmer+. Using the function Automatic terminal RUN/TRANSFER switching in MAC Programmer+ the software automatically put the terminal in transfer mode. To put E50 in manual transfer mode you press the keys [F3] and [F4] simultaneously as the voltage feed is connected.

Run

Run-time mode is where the application is running. When switching to run-time mode, block 0 is automatically displayed.

In the terminal the built in keyboard is used to select and change values in run-time mode.

An error message is shown on the display if a communication error should occur between the terminal and the PLC system, See appendix. The terminal starts automatically when communication restarts. Key sequences affecting I/O that have been pressed during a communication error are stored in the terminal buffer and will be send to the PLC system when the communication is running again.

To get a watch-dog function, where the PLC system can detect if a communication error has occurred, the terminal clock continuously can be transferred to a register in the PLC system (see the section Date/Time format in the chapter *Programming via MAC Programmer+*). The PLC system checks if the register is updated and if not, an alarm indicating communication error can be set in the PLC system.

How the different objects/functions works in run-time mode are described in respective section of this manual.

3.2 The terminal's keyboard

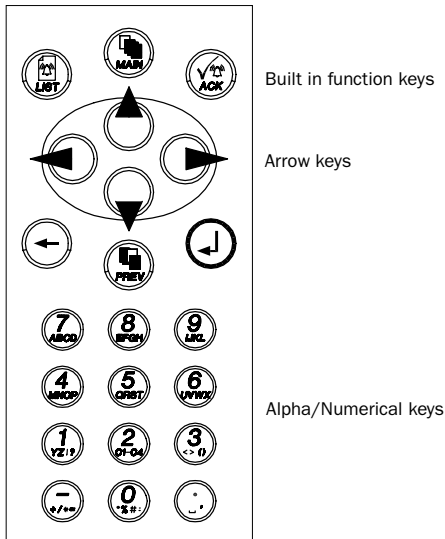

Alpha/numerical keys

From the alpha/numerical keyboard the following characters can be entered in dynamic text and numerical objects during run-time in the terminal.

0-9

A-Z

a-z

! ? < > () + / * = ° % # : ' .

National characters

Note!

No characters can be entered from the keyboard on E50 because it don't have any numerical keys.

Numeric values are entered by pressing the respective key once. A to Z are entered by pressing the respective key 2 to 5 times and the lower case (small) letters a to z are entered by pressing the respective key 6 to 9 times. The time interval between the pressing can be set (see the section Key delay time in the chapter *Programming via MAC Programmer+*). If the key is not pressed within the time interval the cursor is moved to the next position.

Pressing the key C1-C4 two to nine times different national characters are entered. This make frequently used characters that are not standard on the alpha/numerical keyboard available in the terminal (see the section Country settings in the chapter *Programming using the MAC Programmer+*).

Note!

In MAC Programmer+ all characters in the used font table (see the section Country settings in the chapter *Programming via MAC Programmer+*) except reserved characters can be used as a static text. Write the wanted character by pressing the ALT key and at the same time write 0 (zero) on the numerical keyboard on the PC followed by the character code (see Font tables in the Appendix).

Numerical and alphanumerical keys in E100

To be able to enter figures and letters in E100 you keep the NUM key pressed when you press a figure. As an alternative you can enter the command NTGL on the command line under System signals in the Setup menu. The command NTGL gives the NUM key a toggle function. This means that when you press the NUM key you activate the function for numerical entering. Now you enter figures with the keys. Inactivate entering of numerical figures by pressing the NUM key.

To be able to enter letters in for example text objects in E100 you open the object for editing by pressing Enter. Then you first press the NUM key and then the Enter key at the same time as you press the arrow keys up and down. Move the cursor position with the arrow keys left and right. You enter the sign . by pressing the 0 key twice.

Reserved characters

The ASCII characters 0-31 (Hex 0-1F) are reserved for internal functions in the terminal and may not be used.

Arrow keys

The arrow keys are used to move the cursor within a block, menu or dialog.

Built-in function keys

All keys are not available on all terminals.

The [↵] ([ENTER]) key is used to confirm settings made and go on to the next line/level.

The [PREV] key is used to return to the previous block. If the security level is changed the [PREV] key is disabled.

The [LIST] key is used to bring up the alarm list.

The [ACK] key is used to acknowledge an alarm in the alarm list.

The [MAIN] key is used to jump to block 0 in Run-time mode.

The [←] key is used to delete the character to the left of the cursor.

Note!

When the main block (block number 0) has been shown the [PREV] key doesn't work because the block historical are deleted when the main block is shown.

Note!

With the expansion card IFC 128E it is possible to put all the keys on an external keyboard. For more information we refer to the IFC 128E manual.

Key sequences

There are some key sequences in the terminal with the following functions. Not valid for E100 and E710.

Key sequence	Function
[←] [MAIN]	Switch between PROG and RUN.
[←] [F1]	Hold this combination pressed during start up to activate the mode for downloading of system programs, see the Down load the system program section.
[←] [PREV]	Calls up the information page in run-time mode, see the Information page section.
◀ ▶	Hold this combination pressed during start up to activate the self test function.

The key sequences in E100 and E710 differ from the rest of the terminals and are as follows. For complete description of the functions and procedure see the table above.

Function	E100	E710 v2.xx	E710 v4.xx
Switch between PROG/RUN/SETUP	[←] [ENTER]		[F1] + [F2] + [F4]
Sysload	[←] [F1]	[F1] + [F2] + [F8]	[F1] + [F2] + [F8]
Calls up the information page, see the Information page section.	[←] ▶	Touch key	Touch key
Ativate the self test function.	◀ ▶	[F1] + [F2] + [F7]	[F1] + [F2] + [F7]
Calibrate touch		[F1] + [F2] + [F5]	[F1] + [F2] + [F5]

E50 has only Run-time mode and Transfer mode. The following key sequences are valid for E50.

Key sequence	Function
[F3] [F4]	Put the terminal in manual transfer mode.
◀ ▶	Ativate the self test function.

3.3 Set the real time clock

Not valid for E50.

The real time clock in the terminal is set under **SETUP, Date/Time**.

Select the alternative Set Terminal clock. The date and time is now displayed. Press [SET] to change the settings. Enter required date and time. In the editing mode you move the cursor with the arrow keys. Press [NEXT] to return or interrupt the editing before [ENTER] is pressed.

The real time clock can also be set in run-time mode via a maneuverable clock object.

3.4 Information page

Not valid for E50.

The terminal contains an information page. The information page is activated by simultaneously pressing the [←] and [PREV] keys in run mode. On the touch terminal a touch key can be used/configured to call up the information page.

Parameter	Description
STARTS	Number of times the terminal has been started.
RUN	Number of hours the terminal has been in operation.
CFL	Number of hours the backlighting has been switched on.
DYNAMIC MEMORY	Free RAM memory (working memory) in number of bytes.
FLASH MEMORY	Free Flash memory (project memory) in number of bytes.
FLASH ERASE CNT	Number of times each sector of the Flash memory has been erased. The current spareblock always shows zero.
FLASH CACHEHITS	Percentage of Block/Allocation cachehits in the file system.
FLASH ALLOCS	Max percentage of used/active allocations per block in the file system.
ALARMS	Number of alarms and alarm groups in the application.
TRENDS	Number of trend IO and trend objects in the application.
RECIPES	Number of production methods in the application.
DIGITAL IOs	Number of digital IOs monitored continuously (static) and number in the current block (monitor).
ANALOG IOs	Number of analog IOs monitored continuously (static) and number in the current block (monitor)
IO POLL	Time in ms between two readings of the same IO.
TIMEOUT	Number of time-outs in the communication.
CHKSUM	Number of check sum errors in the communication.
BYTEERR	Number of byte errors in the communication.
FRAME	Number of framing errors in each port.
OVERRUN	Number of overrun errors in each port.
PARITY	Number of parity errors in each port. 1=RS-422 port and 2=RS-232 port.

3.5 “Joystick” function

Not valid for E50 and E710.

With this function it is possible to use the arrow keys as function keys. On the command line under System signals you enter the command AK and an address. For example you can enter AKM100 (the command AK and memory cell M100).

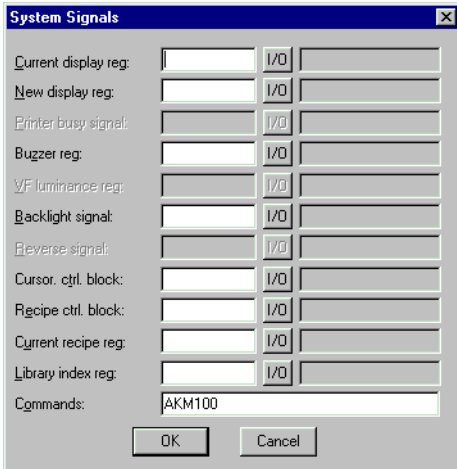

Then M100 is the enable signal and the following 4 memory cells are according to the following control block.

Memory cell	Description
Mn0	Enable. Arrow key detection. Disable=normal function.
Mn1	Left key
Mn2	Down key
Mn3	Up key
Mn4	Right key

If you press an arrow key when the enable signal is set the memory cell corresponding to the key pressed will be set. When the enable signal is set the normal functions of the arrow keys are disabled.

Example

The following example can be used to exit the joystick function and return to normal function. Make the following steps.

- create a block with 1:st man obj defined.
- enter the static text “JOYSTICK”.
- create a digital object with the following settings.

```
D.Signal: M100  
Text 0  : FRÅN  
Text 1  : TILL  
Manoeuvr: JA
```

The textblock will look like this.

```
JOYSTICK #—
```

4 General

This section describes how the terminal is designed as well as the basics for using it. Furthermore there is an explanation of the general rules and object parameters as well as common functions which apply to the terminal.

4.1 Method for programming a project

Building up the application in the terminal graphically provides the operator with concise information on the operation of the system. It is important to organize your application well. Think about which functions are required. Begin at the introductory level and then work down through the levels of detail. When an object is programmed base this on the functions in your application. Each function then becomes one or more blocks depending on how complex the function is. A project can contain both Graphic- and Text blocks and each block can contain static and dynamic objects. To achieve a structured application the block should be created in a hierarchy which makes working natural for the operator.

The application can also be structured as a sequence control.

In the run-time mode it is possible to test all or parts of the application before running.

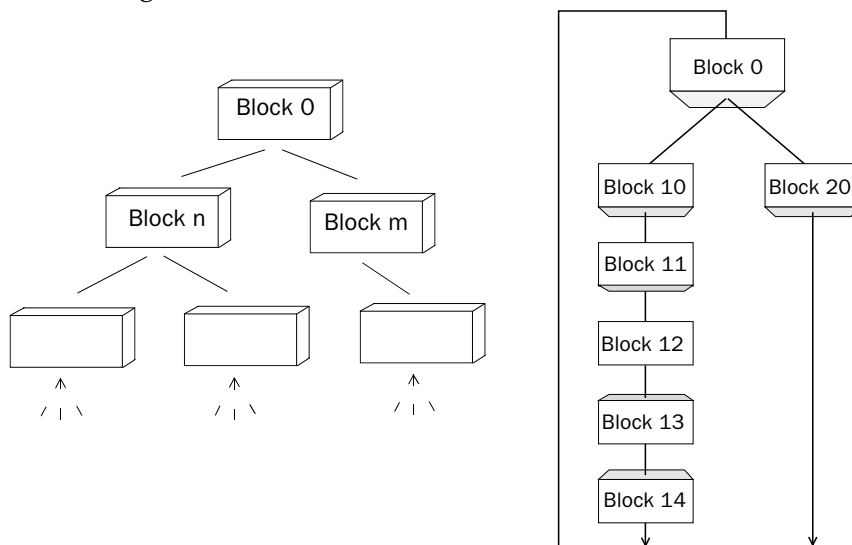

4.2 Efficient communication

To make the communication between the terminal and the PLC system quick and efficient the following should be noted about how the signals are read and what that can be done to optimize the reading.

Signals affecting the communication time

It is only signals to objects in the current block that are read continuously. Signals to objects in other blocks are not read, that is the number of blocks does not affect the communication time.

Besides the signals to objects in the current block, the terminal is continuously reading the following signals from the PLC system:

- Display signals
- Block print-out signals
- LED registers
- Alarm signals
- Remote acknowledge signals on alarms and alarm groups
- Login signal
- Logout signal
- Trend registers at the sample points
- Bargraph registers if using min/max indicators
- New display register
- Buzzer register
- Backlight signal
- Cursor control block
- Recipe control block
- Library index register
- Index registers
- PLC clock register if the PLC clock is used in the terminal
- List erase signal
- No protocol control register
- No protocol on signal

Signals not affecting the communication time

The following signals do not affect the communication time:

- Signals linked to function keys
- Time channels
- Objects in the alarm messages

How to make the communication more efficient

Group PLC signals consecutively

The signals from the PLC system are read most rapidly if all signals in the list above are consecutive. If for example, 100 signals are defined, it is quickest to read these if they are linked to, for example, M0.0-M11.7. If the signals are spread out (e.g. I0.4, Q30.0, T45.3 etc.) the updating is slower.

Efficient block changes

Block changes are carried out most rapidly and efficiently through the block jump function on the function keys or through a jump object. "Display signals" in the block header should only be used when the PLC system is to force the presentation of another block. The "New Display" register can also be used if the PLC system is to change the block. This does not affect communication as much as a larger number of "Display signals".

Use the clock of the terminal

An extra load is put on communication if the clock of the PLC system is used since the clock register must be read up to the terminal. Downloading of the clock to the PLC system also creates an extra load. The interval between downloadings should therefore be as long as possible.

Packaging of signals

When the signals are transferred between the terminal and the PLC system, all signals are not transferred simultaneously. Instead they are divided into packages with a number of signals in each package. To decrease the number of packages and make the communication faster this number has to be considered. The number of signals in each package depends on the used driver.

PLC system	Number of signals in each package	
	Analog signals	Digital signals
FX CPU	32	200
A CPU	116	800
QnA CPU	60	200
A C24	58	200
QnA C24	51	864

To make the communication as fast as possible the number of packages has to be minimized. Consecutive signals require a minimum of used packages but it is not always possible to have consecutive signals. In such cases the so-called waste between two signals has to be considered. The waste is the maximum distance between two signals you can have and still keep them in the same package. The waste depends on the used driver.

PLC system	Waste	
	Analog signals	Digital signals
FX CPU	20	100
A CPU	20	100
QnA CPU	20	40
A C24	20	100
QnA C24	54	864

Signal	1	2	3	4	5	6	7	8	9	10
Used	X	X					X	X	X	



Waste

Operator's pictures

Use graphic blocks for operator communication

If the terminal has graphic blocks use text block is designed in the first place for report print-outs. Text blocks are slower and demand more memory than graphic blocks.

Use the 3-D effects for elegant operator pictures

Combinations of objects with frames and 3-D rectangles can be very effective in graphic blocks. In this context the "lighting" appears to come from the top left-hand corner, that is the "shadowing" is on the under and right-hand edges of raised objects and on the upper right-hand edges of inset objects.

4.3 Menu structure

Normally configuration and programming are carried out with the MAC Programmer+. Each mode consist of different number of menu levels depending on the function. Each level consists of a menu where you make a choice or state a parameter to go on to the next level (menu).

The application is built up of *blocks*, *Graphic blocks* and/or *Text blocks*. Values from the PLC system are shown and altered in the blocks. Each block has a block number between 0 and 989 allocated by the program. Blocks 990-999 are reserved for special purposes, so-called *system blocks*. The terminal is object-oriented which means that a block can contain all the signals linked to an object for controlling and monitoring; a pump for example.

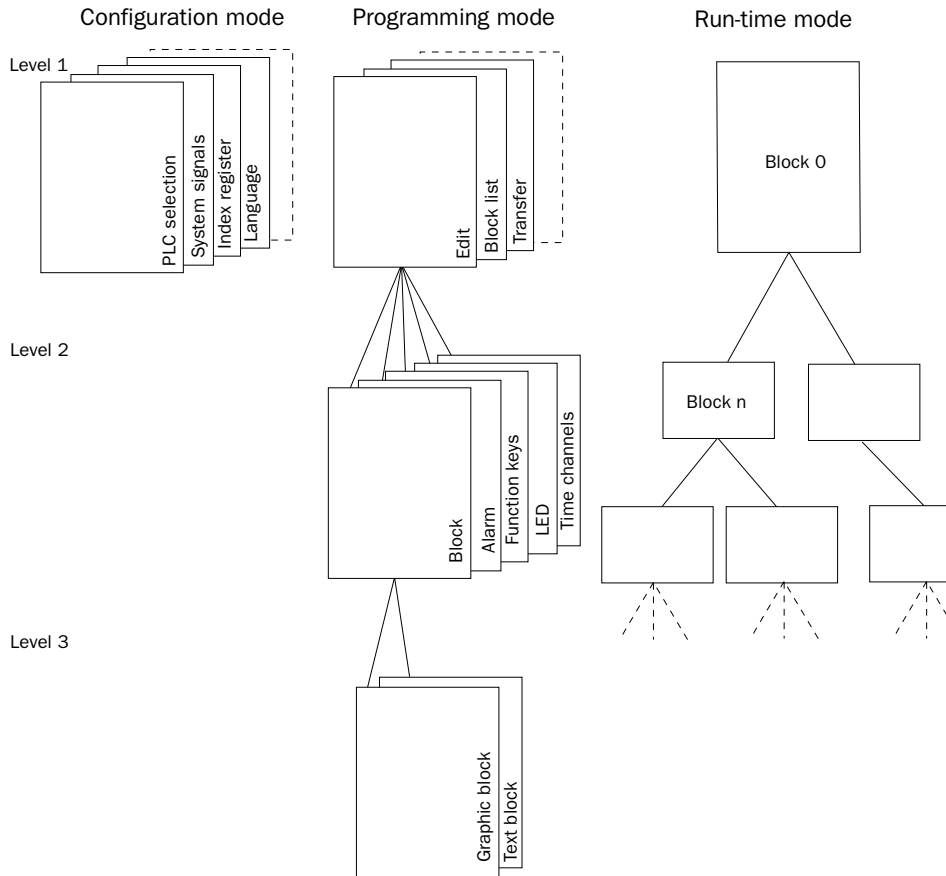

4.4 Blocks

A block header is defined for each block. The block number, type of block, status word etc. are contained in the block header. The alarm, time channels and contrast settings functions can also be called up as blocks. These are called system blocks.

Maximum number of blocks in a project in E100 and E200 are 150. In the rest of the terminals 990

Note!

The block type cannot be altered for a defined block.

4.5 Signal types in MELSEC

The PLC system's signal types are allocated according to the table below. See the PLC system manual for the used for the complete address area.

Digital signals (ON/OFF)

The terminal can handle digital signals of the following types: For addressing other PLC systems we refer to the manual for the drivers respectively.

Signal	Function	A series	FX series	QnA series
X	Input Relay	•	•	•
Y	Output Relay	•	•	•
M	Internal Relay	•	•	•
Dn.x	Bit addressing in Data Registers. Bit x in Data Register n. Hexadecimal addressing of the bits, 0-F.			•
L	Latch Relay	•		•
B	Link Relay	•		•
F	Error Relay	•		•
SB	Link Special Relay			•
V	Edge Relay			•
S	Step Relay		•	•
T	Timer	•	•	•
ST	Accumulated Timer			2
C	Counter	•	•	•
SM	Special Internal Relay			•

Analog signals (Values)

The terminal can handle analog signals of the following types:

For addressing other PLC systems we refer to the manual for the drivers respectively.

Signal	Function	A series	FX series	QnA series
T	Timer	•	•	•
ST	Accumulated Timer			•
C	Counter	•	•	•
D	Data Register	•	•	•
SD	Special Register			•
R	File Register (Bank addressing)	•		•
W	Link Register	•		•
SW	Link Special Register			•
Z	Index Register			•
ZR	File register (Continuous numbering)			•

Note!

32-bit counters (C200-C255) in FX systems can not be monitored.

4.6 Signal format

The following signal format are available in the dialog for each object.

Format type	Range
Signed 16-bit	-32768 – +32767
Unsigned 32-bit	0 – +65535
Signed 32-bit	-2147483648 – +2147483647
Unsigned 32-bit	0 – +4294967295
Float with exponent, 32-bit	$\pm 3,4E38$ Numbers larger than 1000000 are shown with exponent.
Float without exponent, 32-bit	The Positions (including the decimal point and sign) and Decimals states the valid range. E.g. 8 positions and 3 decimals lead to $\pm 999,999$.
BCD Float, 32-bit	0-9999,9999. Only MELSEC AnA PLC system.
BCD 16-bit	0-9999
BCD 32-bit	0-99999999
HEX 16-bit	0-FFFF
HEX 32-bit	0-FFFF FFFF

5 Programming using MAC Programmer+

This section describes how the terminal is programmed using *MAC Programmer+*. For installation instructions we refer to the chapter *Installation*.

All the functions can be reached with MAC Programmer+ from the menu:

File **E**dit **V**iew **F**unctions **S**etup **B**lock Manager **T**ransfer **W**indow **H**elp

5.1 Creating a project

A new project is created by selecting **New** in the menu **File**. The **Project Settings** dialog is now shown. Here you can select the controller system, type of terminal and color scheme.

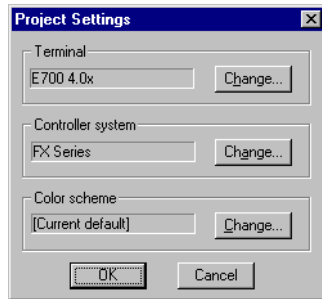

Terminal:

Press **Change...**

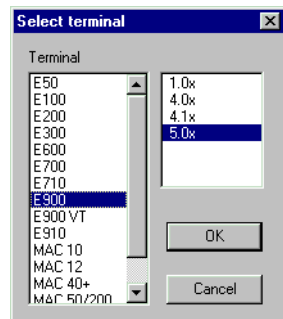

Select terminal type and version (system program) for current terminal type.

Controller system:

Select here the controller system to which the terminal is to be connected. When you press the **Change...** button the following dialog is shown. The list shows installed drivers. Here you select Brand name, protocol and controller model.

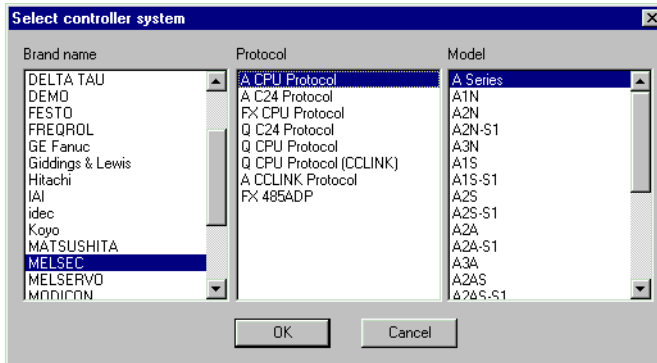

Update drivers from Internet

To update available drivers to the latest version or to install new drivers from Internet you use the function **Update terminal drivers, from Internet** in the **File** menu. All project must be closed before this function is used. The computer must be able to make an Internet connection. You don't need a browser. When the connection is established a list showing all drivers that can be downloaded from Internet to the computer.

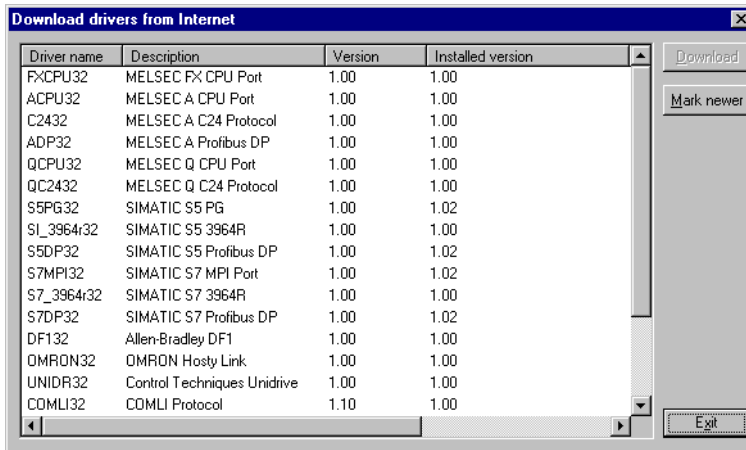

The list shows the version number of available drivers and the version number of installed drivers. Mark the driver/drivers you want to install in the MAC Programmer+. The function **Mark Newer** will mark all drivers that are available in a newer version than the one installed and the drivers not installed. Then you select **Download**. Each driver is approximately 500 kb and it is ready to use when the download is ready.

Update drivers from disk

To update available drivers to the latest version or to install new drivers from disk you use the function Update terminal drivers, from Disk in the File menu. All project must be closed before this function is used. Open the mpd file in the map where you find the drivers. Now a list showing available drivers is displayed.

The list shows the version number of available drivers and the version number of installed drivers. Mark the driver/drivers you want to install in the MAC Programmer+. The function **Mark Newer** will mark all drivers that are available in a newer version than the one installed and the drivers not installed. Then you select **Download**. Each driver is approximately 500 kb and it is ready to use when the download is ready.

Color scheme:

In terminals supporting colors you can create your own color scheme and store it under a unique name. The color scheme decides the default color of the background, menus, dialogs, objects etc. When you select an object in the toolbox or in the menu the colors of the object are shown as defined in the color scheme.

When you select **Change** the following dialog is displayed. Here you change the current color scheme or create a new one.

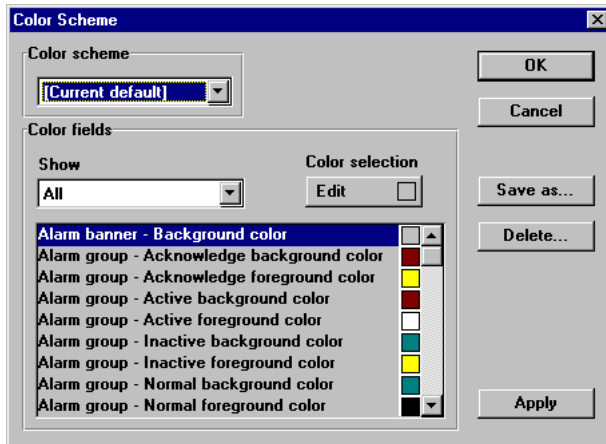

The **Apply** button update all colors in the project, except lines, circles, rectangles and arcs.

5.2 Changing project settings

Both the selected terminal and the controller system can be changed in the project. Choose **Project settings** in the **File** menu and press **Change** at the parameter Terminal and/or controller system.

If you update the system program in the terminal to a newer version you must change to the correct terminal version in the Project settings dialog. If this is not done the new functionality in the new terminal version can not be used.

If you change the controller system in the project to a system with other names of the used devices these must be changed. It is easily done by using the internal name list, see the section Name list.

1. Choose **Name list** in the **View** menu.
2. Select **Undefined** to insert all I/O's used in the project to the name list.
3. Select **Export** to export the name list to a text file. State a name and press **Save**. Define how the text file will be separated.
4. Pick up the text file in a text editor, e.g. Wordpad.
5. Change all the I/O's to devices used in the new controller system and save the file as a text file.

6. Select **Import** in the Name list dialog and press **No** on the question if invalid I/O's should be removed.
7. Select **Rebind** to update all new I/O's in the project with the new device names.
8. Choose **Project settings** in the **File** menu and press **Change**.
9. Select the new controller system you want to change to and press **OK** twice.

5.3 Creating a block via the Block Manager

The Block Manager is shown when you have created a project. The system blocks included in an application are shown.

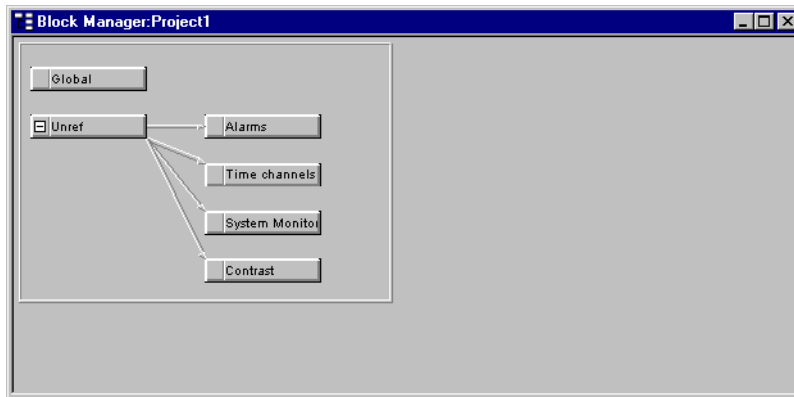

Note!

E50, E100 and E200 has not the block Contrast. Only E700 and E710 has the System monitor.

In the Block Manager there is a toolbox with the following functions.



Mark block and create block.



Add a new block.



Define block header for selected block.



Make a block jump to the block to be created with the cursor.



Make function key block jump to the block to be created with the cursor.



Delete selected block.



Edit selected block.



Block Manager settings.



Zoom in.



Zoom out.

Define block

When you add a block in the Block Manager the following dialog is shown. It is a simplification of the complete block header.

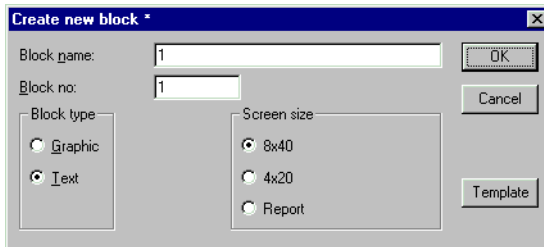

Block name:

A name for the block can be written here. The block name is shown in the Block Manager and in the block list.

Block no.:

The number of the block. The defined values are entered automatically if a block with assigned number already exists. The block number 0 is shown automatically on starting up and must always be used in a project.

Block type:

Select block type, graphic or text.

Screen size:

Select character size for textblock. The character size can not be changed for a defined object. .

Template:

Here you can copy a template to the block or save the block as a template.

Define the complete block header

Basic parameters valid for each single block are defined in the block header. Select **Header** in the **Block Manager** menu. The following parameters can be defined in the block header:

The screenshot shows the 'Block Header' dialog box with the following fields and controls:

- Block no.:** Input field containing '1'.
- Block name:** Input field containing '1'.
- Display signal:** Input field with 'I/O' indicator.
- Print signal:** Input field with 'I/O' indicator.
- Completion signal:** Input field with 'I/O' indicator and a **Reset** checkbox.
- Send mail signal:** Input field with 'I/O' indicator.
- Mail completion signal:** Input field with 'I/O' indicator and a **Reset** checkbox.
- Mail to address:** Input field with a browse button (...).
- Attach file:** Input field.
- Security Level:** Dropdown menu set to '0'.
- Background block:** Input field with a dropdown menu.
- Cursor color:** Color selection box.
- Cursor thickness:** Input field set to '1'.
- Block type:** Radio buttons for **Graphic** (selected) and **Text**.
- Buttons:** **OK**, **Cancel**, **Status...**, **Ekeys...**, **Keyfield...**, and **Template**.

Block no.:

The number of the block. The defined values are entered automatically if a block with assigned number already exists. The block number 0 is shown automatically on starting up and must always be used in a project.

Block name:

A name for the block can be written here. The block name is shown in the block list.

Display signal:

A digital signal which when activated results in the block being shown on the display. If display signal are used they should be ordered consecutively, for the different blocks to get the best performance. This field is not filled in if another method for changing block is used.

Print signal:

A digital signal which when activated results in the block being printed out on a connected printer. The display signal and printer signal can be the same. The printer signals should be used consecutively to print out as quickly as possible.

Completion signal:

A digital signal which is activated by the terminal when the print out is completed. Normally the signal is set. If the function Reset in Block Header is marked then the signal is set to zero when the print out is completed.

Note!

Only textblock can be sent as email message.

Send mail signal:

The message is send when stated signal is set.

Mail completion signal:

A digital signal that is activated by the terminal when the message is sent. Normally the signal is set. If you mark the function Reset the signal will be reset when the message is sent.

Mail to address:

Enter the email address to the receiver. Select up to eight receivers from the list shown when you click on the ... button. The list of email addresses is defined in the dialog **SMTP Client Service** under **Network Services** in the **Setup** menu.

Attach file:

Enter the name of a trend or recipe file to be attached to the message. If there is a trend file and a recipe file with the same name the trend file is sent.

Security level:

A security level (0-8) for the block is stated here. The operator must enter a password to enter the block. It must be equivalent to a given or higher security level if a security level > 0 is stated.

Background block no:

Here you have the possibility to load another graphic block as a background in current block. For example if you want to use the same background in more than one block. When the graphic block editor is active you can select if the background block shall be shown in current block with the function **Show Background Block** in the **Window** menu.

Cursor color:

Select the color of the cursor in graphic blocks.

Cursor thickness:

Select between three different alternatives of the cursor in graphic blocks.

Block type:

Select block type, graphic or text. It is not possible to change block type for a defined block.

Screen size:

Select the character size in the text block. It is not possible to alter the type of a defined block.

Fkeys:

The local function keys for the block are defined here. See the chapter *Function Keys*.

Keyfield:

Valid in E100, E200 and E300. Here you define leadtexts for the function keys. Enter a freely defined text of maximum six characters in E200 and E300 and maximum five characters in E100. The bottom line of the block will be occupied. For the other terminals please refer to the chapter *Graphic presentation and maneuvering*.

Template:

Here you can copy a template to the graphic block or save the block as a template.

Status:

States the display's appearance in the run-time mode. The status word has no function in the system blocks. The parameters in the status word have the following functions.

Cursor off: States if the cursor will not be visible in the text block in the run-time mode.

Put cursor at first man. object: States if the cursor in the text block will be on the first maneuverable object instead of in the top left-hand corner.

Disable main menu key: States if the [MAIN] key is to be blocked in the run-time mode when the block is shown on the display.

Disable alarm list key: States if the [LIST] key is to be blocked in the run-time mode when the block is shown on the display.

MORE indication: States if the + sign is to be shown in the bottom right-hand corner and the top right-hand corner when there is more of the text block below and above respectively than that shown on the display.

Auto data entry: States if the cursor will automatically move to the next maneuverable object after an entry. The cursor can only be placed on maneuverable objects in this state.

Disable Prev Key: States if the [PREV] key and the function "Return to previous block" for the function keys is to be blocked in the run-time mode when the block is shown on the display.

Settings for the Block Manager

Here you make the settings for the presentation in the Block Manager.

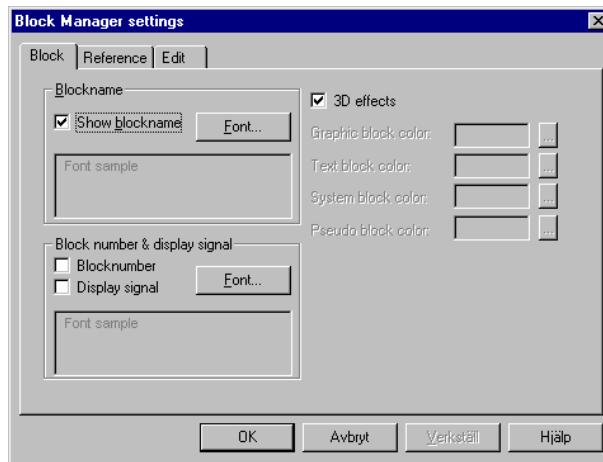

Block:

Select how data should be presented in the block.

Reference:

Select the appearance of the Block Manager.

Edit:

Select special functions for the presentation in the Block Manager.

Show terminal around the working area

To graphic blocks there is a function in the **Window** menu called **Show terminal**. When this function is active a picture of the current terminal is drawn around the working area. The picture of the terminal has pressure sensitive surfaces on functionkeys, LEDs and leadtext fields.

Define function keys

When you double click on a function key you can select to define a local or global function key. The editor for selected function is displayed.

Define LEDs

When you double click on a LED the editor for defining LEDs is displayed.

Create insertable strip

When you double click on a field on the insertable strip a dialog is displayed where you can enter a text, select adjustment of the text and select font. This function makes it possible to create the whole insertable strip and printout it on plastic film and then use it in the terminal.

5.4 Programming blocks

Double click on the current block or select Edit for marked block. The working area for the block and the toolbox are now shown. The working area is the graphic block editor and the text block editor depending on if you open a graphic block or a text block. The objects that can be created in the block are in the tool box.

Select an object by clicking on the object in the toolbox, and place the cursor in the working area where you want the object to end up. The dialog for selected objects is shown when you click. Enter the parameter values in the dialog and press OK. The object is now shown on the working area. If you have selected static text or graphics, it is written directly on the working area.

General parameters for the objects are described in the chapter *General*. Each type of object is explained in the chapters *Graphic Presentation and Maneuvering* and *Text-based Presentation and Maneuvering*.

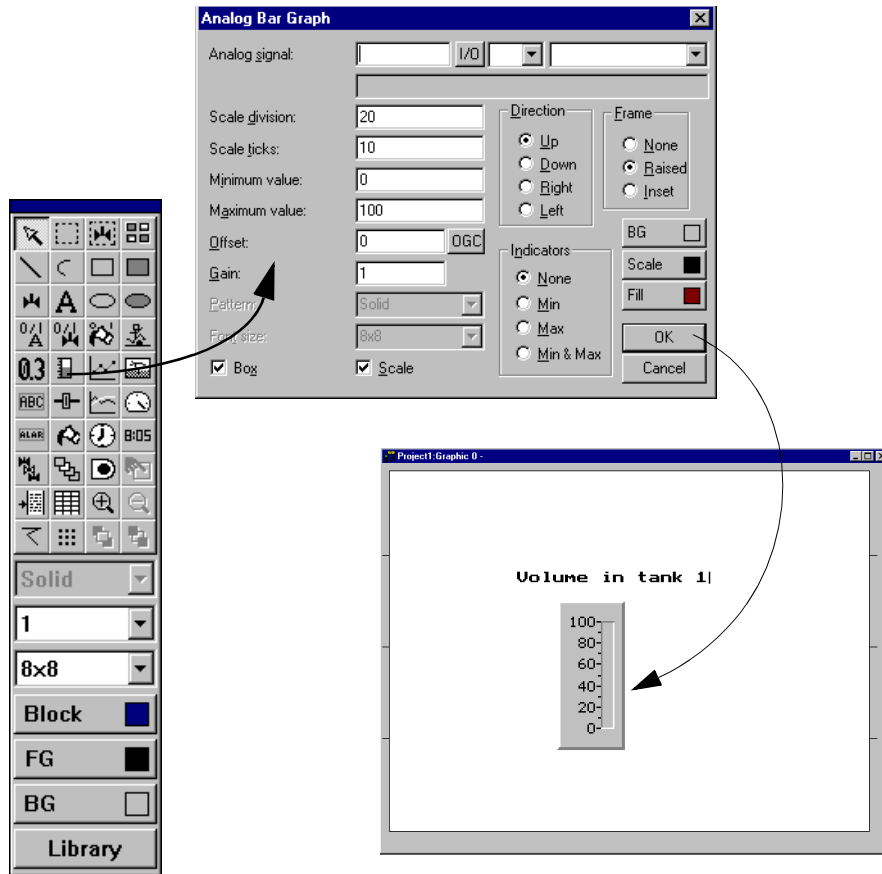

5.5 The graphic block editor

Not valid for E50, E100 and E200.

This chapter describes the graphic block editor in the MAC Programmer+. The editor is based on Windows standards.

In the graphic block editor you create graphic blocks with static and dynamic graphics.

How to open the graphic block editor

The graphic block editor is opened when you double click on the current block in the Block Manager or from the block list.

Mouse, keys and the cursor

The following section describes how to use mouse and keys in the graphic block editor. Further more we describe the different shapes of the cursor.

Mouse

Use floating toolbox to create object.

Click on object to mark it.

Mark several objects by drawing a frame around the objects or by holding the Shift key down when you click on the objects.

Keep mouse button down on object and drag mouse to move it.

Keep mouse button down on object and press the Ctrl key and drag the mouse to copy it.

Keep mouse button down on object handle and drag mouse to size it.

Double click on object to view parameters.

The following picture shows marked objects.

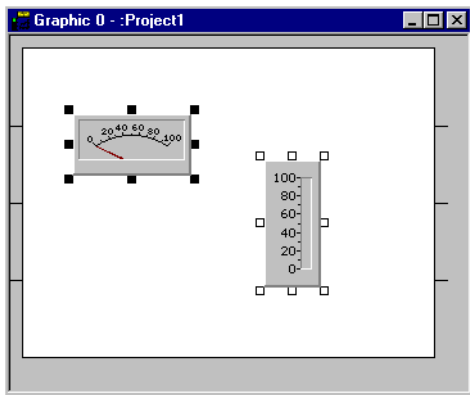

Keys

Use the Object menu to create object.

Use arrow keys to move cursor.

Use [Ctrl] + [arrow keys] to move on pixel level.

Press [SPACE] on object to mark it.

Mark several objects by selecting Block Select in the Object menu and drag a frame around the objects using [SPACE] and arrow keys.

Keep [SPACE] down on object and use arrow keys to move it.

Keep [SPACE] down on object handle and use arrow keys to size it.

Press [ENTER] to view parameters on marked object.

Cursor

The cursor has four different shapes



within an object



change size of an object



in graphic working area



selection in menu or toolbox

The toolbox

In the editor you use the toolbox to create objects in the block. All functions are also available in the menus. The following table describes the functions in the toolbox. See the chapter *Graphic presentation and maneuvering* for the different objects that can be used in graphic blocks.



Selection pointer mode



Area selection mode



Symbol creation mode



Zoom in



Zoom out



Grid



Put on top



Put to background



Line pattern



Line thickness



Character size



Background color for the block



Foreground color for the object



Background color for the object



Import/export symbols.

Create object

Select the type of object in the toolbox and drag the object. Static graphics will be displayed when you click in the editor. Dynamic objects are defined in a dialog box before they are shown on the display.

When an object is drawn it is marked with handles and the function selection pointer mode is activated.

Recommendations

When the graphic block editor is active there is a command in the **Window** menu to turn **Draft Move & Size** on/off. It is recommended to turn this option on when using a slow computer. This turns off the immediate updating of the sized/moved object. A check mark appears next to the menu item when Draft Move/Size is on.

In the **File** menu you will find the function **3D Controls**. This functions means that the forms in the program will be displayed with 3D effects. It is recommended to turn this function of when using a slow computer.

Static graphics

The static graphic objects are line, arc, ellipse, rectangle, polygon, symbol, text and decorations and are used to create background graphics.

Dynamic objects

Select the type of object in the toolbox and place it in the block. Before the object can be shown on the display you must define the object in the displayed dialog . See the sections *Graphic presentation and maneuvering* for further details about object settings.

Select several objects

In the graphic block editor you can select several objects in two different ways.

- Click outside the object, keep the left mouse key pressed and draw a frame around the objects you want to select. The latest created object will be shown with filled handles.
- Select the selection cursor in the toolbox. Keep the [Ctrl] key pressed while you select the objects. The latest selected object will be shown with filled handles.

Place object

To easily adjust the placing of the objects in graphic blocks there are a number of functions in the Layout menu. Under this menu you will find the functions **Align**, **Make same size**, **Space evenly** and **Tile**. The function are also available in a separate toolbox.

To use the functions two or more objects must be selected. The functions calculate the placing from one or two reference object. For the functions Align, Make same size and Tile it is the last selected/created object that is the reference object, see the section *Select several objects*. For the function Space evenly it is the uppermost and the lowermost objects that are the reference objects. The reference objects are not affected by the function.

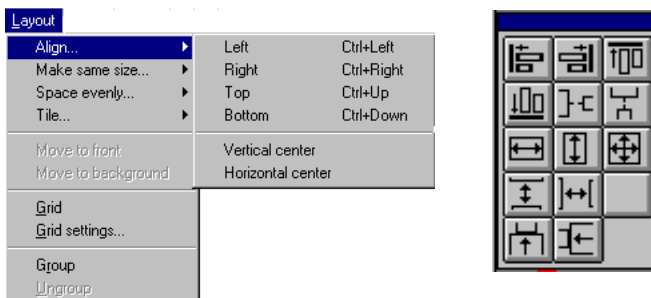

Align

Under Align you have six alternatives for adjusting the objects horizontally and vertically.

Left

This left-aligns the marked objects with the reference object.

Right

This right-aligns the marked objects with the reference object.

Top

This top-aligns the marked objects with the reference object.

Bottom

This bottom-aligns the marked objects with the reference object.

Make same size

Under Make same size there are three alternatives for making the marked objects the same size.

Width

Adjust the marked objects so that their width is the same as the reference object.

Height

Adjust the marked objects so that their height is the same as the reference object.

Both

Adjust the marked objects to exactly the same size as the reference object.

Space evenly

Under Space evenly there are two alternatives for adjusting the space between marked objects

Vertical

Adjusts marked objects with an even vertical spacing. The uppermost and lowermost objects retain their positions. At least three objects must be marked.

Horizontal

Adjusts marked objects with an horizontal spacing. The leftmost and rightmost objects retain their positions. At least three objects must be marked.

Tile

Under Tile there are two alternatives for adjusting objects so that they are edge-to-edge.

Vertical

Adjusts marked objects so that they align vertically edge-to-edge with the reference object.

Horizontal

Adjusts marked objects so that they align horizontally edge-to-edge with the reference object.

How to group object

In the Layout menu you can select to group several objects. The grouped objects are handled as an object that can be resized. Color and font can be changed individually for object in the group object. When you click on a object in the group object the dialog for the object is displayed. Mark the objects you want to group and select the function **Group** in the **Layout** menu.

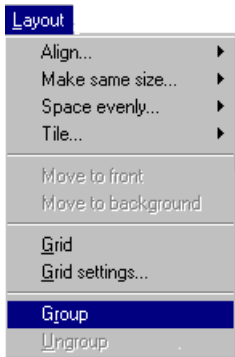

With the function **Ungroup** in the **Layout** menu you release the group object.

Save and load group object

If you mark a grouped object and press the button **Library** in the toolbox in the graphic block editor you can save the object. When you press the button library without any object marked you can load grouped objects stored on the computer. MAC Programmer+ is delivered with several grouped objects. The objects are stored in c:\Program\Beijers\MAC Programmer+\lib\library\.

Create series

In the graphic block editor you can create series of objects. First you create two rows and/or columns with the same object.



Thereafter you mark the objects and select the function **Create series** in the **Object** menu.

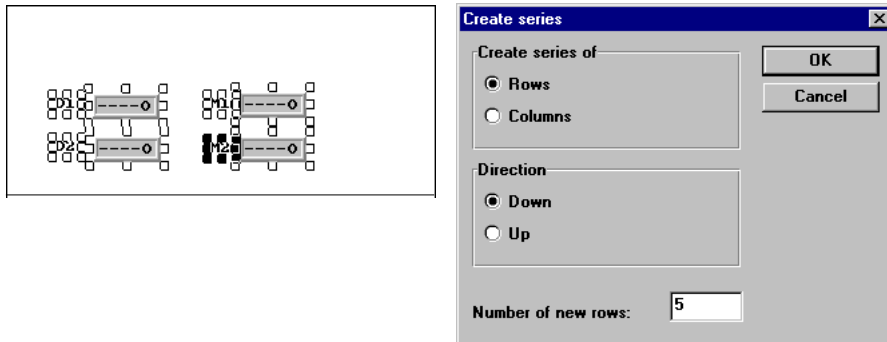

A dialog is now displayed where you select to create rows or columns, the number of rows/columns and in which direction the series shall expand. MAC Programmer+ now creates a table with the assigned number of rows or columns.

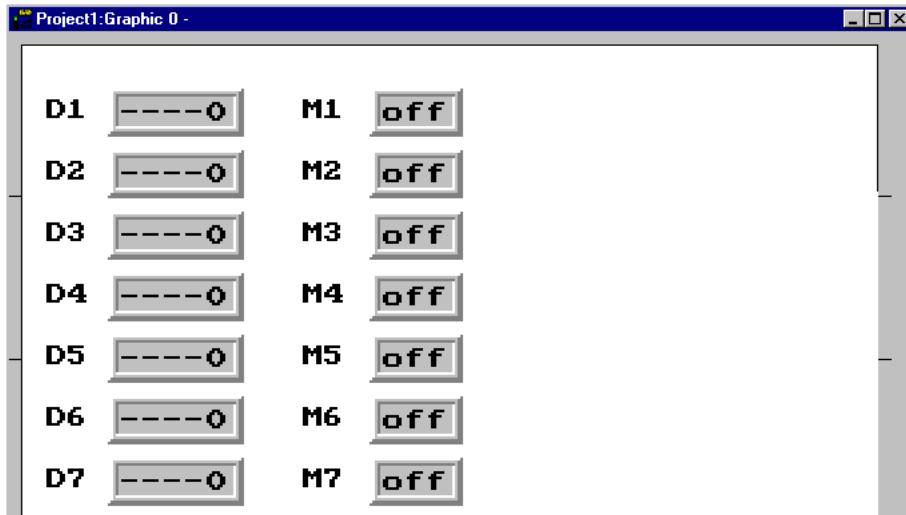

Note!

To be able to create the table the last character in the leadtext must be a figure. The object Alarm banner are not allowed in a table.

Symbols

You can create symbols in three ways, using the Symbol manager, with the functions Create symbol or copy graphics from other Windows programs using the clipboard. See separate chapter how to use the Symbol manager

The function Create symbol

- Select the function Create symbol.
- Drag a marking frame around the graphic you want to save as a symbol.
- State the name of the symbol, max 8 characters.

The symbol is now stored in the symbol directory with the stated name.

Copy graphics from other programs

- Use the copy function in another program (e.g. Paint).
- Make graphic block active in the MAC Programmer+ and select Paste.
- State the name of the symbol, max 8 characters.

The symbol is now stored in the symbol directory with the stated name.

With the functions copy and paste in the MAC Programmer+ it is possible to copy graphics and symbols between blocks and between projects.

Note!

When you copy user-defined symbols between projects, the symbol itself will only be copied if the symbol does not already exist in the target project.

5.6 The text block editor

This chapter describes the text block editor in the MAC Programmer+ . The editor is based on Windows standards.

In text block editor you build up dialogs and reports. A text block can consist of static text and dynamic objects. Static text is text which is not changed when executing the program. Dynamic objects are objects which are linked to the signals in the PLC system.

How to open the editor

The text editor is opened by double clicking on the current block in the Block Manager or from the block list. In the block list you select a defined text block or create a new text block.

Mouse and keys

Click at the beginning of the text you want to mark and drag the mouse pointer over the text. If you are using the keyboard press on shift and arrow keys.

The function Cut will erase marked text.

The character End of line is stated when you press the key combination [Ctrl] [Enter].

Double click or press [F4] on object to view parameters.

The toolbox

In the text block editor there is a toolbox with the following functions. All functions are also available in the menus. See the chapter *Textbased presentation and maneuvering* for the different objects that can be used in text blocks.



Zoom in



Zoom out



ASCII choice list. Selection of characters not available
on the keyboard

Define text block

Static text

The text block editor is a text editor in which you type the static text. You can also use the Windows functions copy/paste in or between blocks, or from other Windows programs e.g. Microsoft Word. This makes it easy to create documentation of your application.

Dynamic object

You can define a dynamic object anywhere in the text. Select the type of object in the toolbox or in the object menu and then you define the object in the dialog displayed.

The dynamic objects are signed with the character # followed by one or several '-' depending on the number of positions in the object. For further details about definition of dynamic objects, see the chapter *Textbased presentation and maneuvering*.

5.7 The symbol manager

Not valid for E50.

In the symbol manager you have the possibility of importing and exporting symbols. You can also create and delete user-defined symbols from the symbol directory. In the symbol list you can see the user-defined symbols. The predefined symbols are not shown, since they are not changeable. How to create a symbol is described in the section *Symbols* in this chapter.

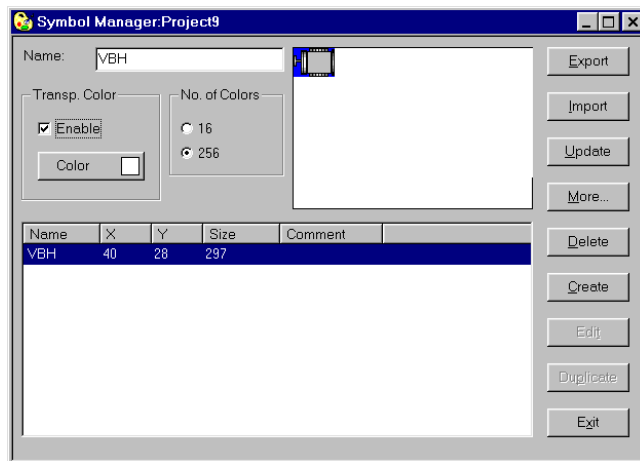

Export symbols

Symbols can be exported in BMP-format to be used in other applications. Only black and white BMP-files can be used in E300 and E600.

Import symbols

The import function makes it possible to reuse symbols from other applications.

Picture files in format bmp, cmp, dex, fpx, jpg, mpt, pcd, png, tga, tif and pcx can be imported into the symbol directory from other Windows applications e.g. Paint. Only black and white BMP-files can be used in E300 and E600.

MAC Programmer+ is delivered with several symbol libraries containing different symbols, e.g. pump symbols. The symbols are stored in c:\Program\Beijers\MAC Programmer+\lib\bitmap\.

Create

The function Create is used to create new symbols. When you select Create, you first have to enter a name of the symbol. When you click OK the bitmap editor is open. The bitmap editor works as a usual drawing program with the limitation according to current terminal.

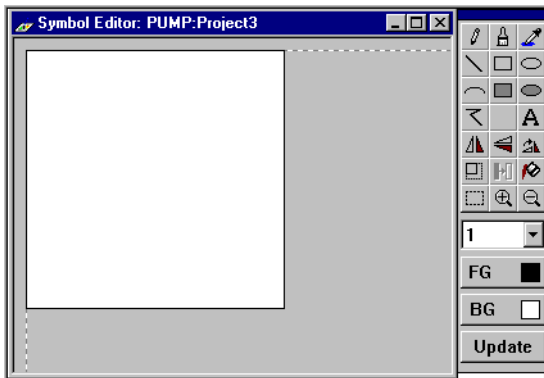

Delete

When you press the right mouse button and draw with the pen, you draw with the background color. If the background color is white it looks like you delete.

Edit

The function Edit activates the bitmap editor for a defined symbol.

Duplicate

The function is used to create a copy of current symbol with a different name.

The More function

The More function is used to add more information to the symbol:

File name:States the file name if the symbol was imported from a file.

Date created:States the date the symbol was created.

Source: States the source of the symbol.

None: Unknown source

Bitmap file:Imported from bitmap file

Clipboard:Imported from clipboard
(Copy & Paste function)

Graph block:Created in a graphic block

Comment:Here you add your own comment to the symbol.

The Delete function

The Delete function is used to delete a symbol from the project.

The Transparent color function

When you import a symbol you can select one color in the symbol to be transparent.

The function No. of Colors

In E700 and E710 supporting colors you can select to handle symbols in 16 or 256 colors.

5.8 I/O change

With the function I/O change you can change a single I/O or move a whole I/O area. You can change I/O in the whole project or only in the object that was marked when you selected the function.

You can use the function on block in the block list, object in the graphic block and text block editor, lines in the alarm list, lines in the function key editor, lines in the LED editor or lines in the crossreference list.

Select the function **I/O change** in the **Edit** menu.

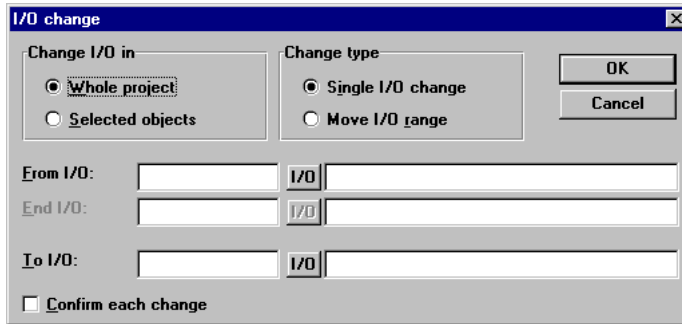

Change I/O in

Select if you want to change I/O in the whole project or for selected objects.

Change type

Select if an I/O shall change place or if you want to move a whole I/O area.

From I/O, End I/O, To I/O

State the I/O to be changed and what it should be changed to or which I/O area you want to move.

5.9 Change BDTP station

With this function you can change the index numbering in a BDTP client project in a BDTP network. For example from station 1 to station 3. Select the function **BDTP Station Change** in the **File** menu.

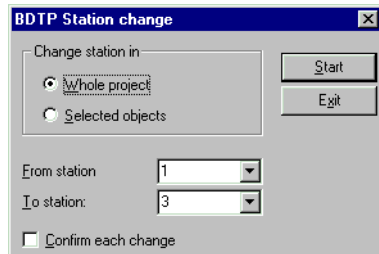

Change station in

Select if you want to change the index numbering in the whole project or for selected objects.

From station, To station

Enter the index number to be changed and to which BDTP station index number to be changed to.

Confirm each change

Select if you want to confirm the change of BDTP station for each object.

5.10 I/O crossreference

The function crossreference is used to document I/O in a clear way. Select the function **I/O Crossreference** in the **View** menu.

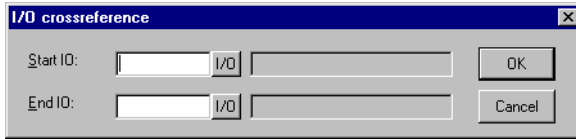

In the dialog displayed you state the Start I/O and End I/O. If you leave the Start I/O field empty, all I/O up to the value in the End I/O field will be included. If you leave the End I/O field empty, all I/O from the value in the Start I/O field will be included. If you leave both the fields empty all I/O in the list will be included.

Presentation

The result of the function will be presented in a list with two levels. The first level shows used I/Os and how many objects that refer to respective I/O.

You reach the second level when you double click on the + character to the left of the I/O. Now the objects containing the I/O you clicked on are displayed. The + character will become a - character. The button Print View opens the print dialog and you can select to print the crossreference list as it looks on the display to a connected printer.

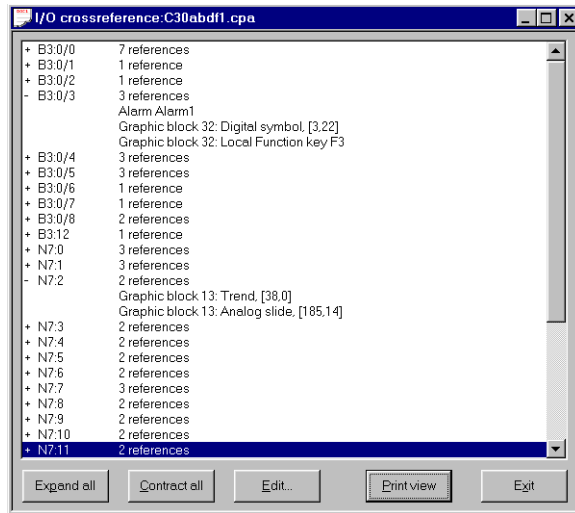

One or several lines in the list can be copied and pasted into e.g. a Microsoft Word document.

5.11 Other editors

The MAC Programmer+ also has editors for handling Function keys, LEDs, Alarms, Alarm groups, Passwords and Time channels. These editors are activated from the **Functions** menu. The editors work in a similar way. The parameters are described in separate chapters in this manual.

Defined Function keys, LEDs, Alarms, Alarm groups and Time channels are displayed in a list in the editors respectively. Add a new definition with **Append** or **Insert**. If you want to change a definition, mark the alarm, make the changes and press **Update**. If you want to update or append more than one definition to the list, press Update or Append once and then press Enter. Thereafter Update or Append remain operational until changed. Erase a marked definition with **Delete** or **Clear**. End the editor with **Exit**. The following example describes the Alarms editor.

The alarm is numbered automatically. When you press Append the alarm definitions is listed last, and when you press Insert the new definition will always be inserted before the marked definition in the list. When you press Update you confirm changes made on a definition.

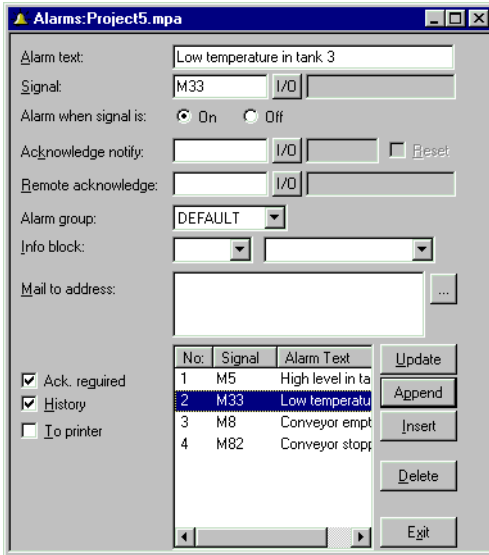

5.12 The File Menu

There are functions for creating, opening, saving and closing projects in the **File** menu. Printer settings, previewing print out, creating documentation headers and activating print out are also selected from here. Furthermore there are functions for testing a project and altering project settings. With the function MELSEC I/O Naming you select if the internal name list should be used or if a name file from MELSEC MEDOC or MELSEC MEDOC *plus* should be imported.

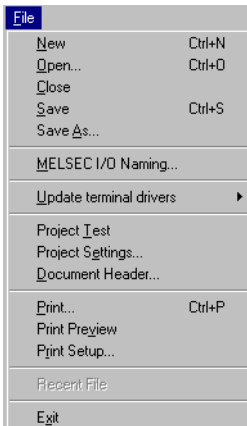

5.13 The Edit Menu

Functions for cutting, copying, pasting, undo and select all are found in the **Edit** menu.

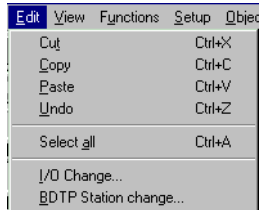

5.14 The View Menu

Function editor for block editing, symbol handling, crossreference and name list are to be found in the **View** menu.

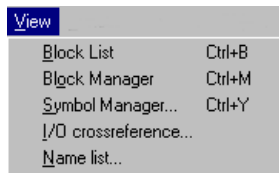

Block List

Blocks included in the application are shown in the block list. In the block list you create new blocks by pressing the button **New**. Basic parameters for the block are defined in the block header.

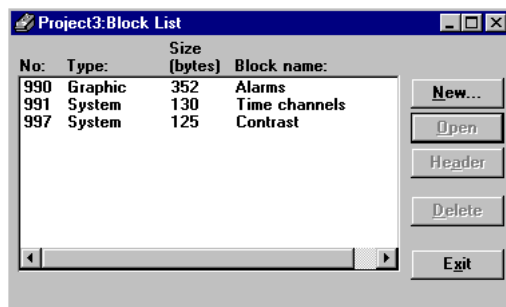

Block Manager

Blocks included in the application are shown in the Block Manager graphically. In the Block Manager you create new blocks, define the block header, define block jump with the functions in the toolbox.

Symbol Manager

Activates the symbol manager. In the symbol manager you create a library of symbols in BMP format. The symbols in the symbol manager are then available in the symbol list when you create static and dynamic symbol objects. It is also possible to duplicate and edit defined symbols.

I/O Crossreference

Under I/O Crossreference you document I/O in a clear way. See the section *I/O Crossreference* in this chapter.

Name list

Under **Name list** you define a local name list for used devices. Devices used in the project without defined name can be inserted in the name list with the function Undefined. New devices can be added and existing names can be edited and updated. With the function Rebind you update the project with the changes done in the name list.

A name list can be exported to a text file and a text file can be imported to a name list. The items in the file is separated either with the character →, ; or ,. An internal name list can be sorted. The text file may not include national characters.

Note!

In the function MELSEC I/O Naming in the File menu you must choose Internal name list to use the name list.

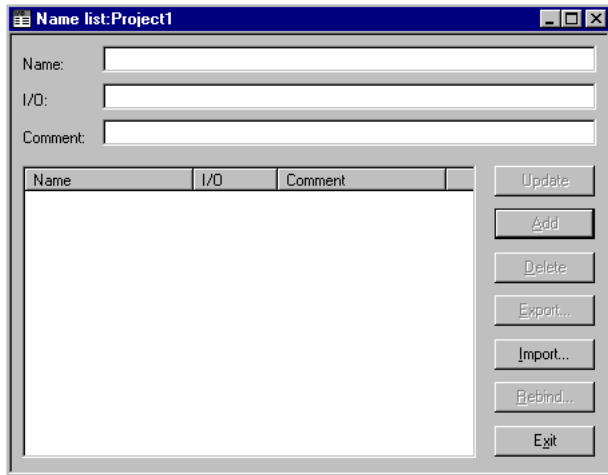

If you have created a local name list in your project you can choose I/O signals from this name list via the I/O button. Click on the button I/O in all instances where you want to enter an address. The I/O browser has incremental searching. Incremental searching means that searching begins immediately while you are still entering characters in the name/device.

The I/O list is stated in device order or name order.

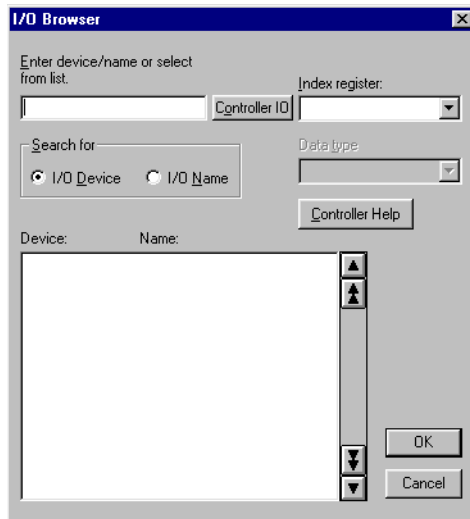

If you have linked a driver specific name file to your project you can choose I/O signals from this name file via the I/O button.

Controller I/O

The button I/O in the I/O browser can give you help with addressing different PLC-systems.

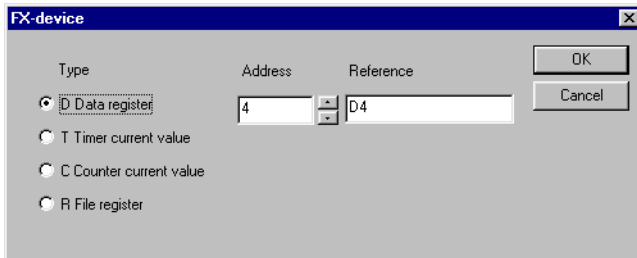

Note!

The function Controller I/O is not supported by all PLC-systems.

5.15 The Functions Menu

Function editor for function keys, LED, alarm, time channels, passwords and message libraries are to be found in the **Function** menu.

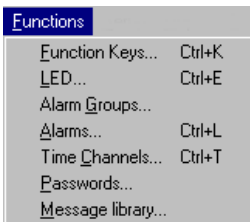

Function keys

Under Function keys you define global and local function keys. See the chapter *Function keys*.

LED

Under LED you define the function for the LEDs. See the chapter *LEDs*.

Alarm Group

Under Alarm Group you can group alarms; for example, by danger level - so that they can be more reality identified and dealt with. See the chapter *Alarm handling*.

Alarms

Under Alarms you define alarm messages and the signal to be connected which will activate the alarm. See the chapter *Alarm handling*.

Time Channels

Under Time Channels you define the time channels used to control events in the process at specified times. See the chapter *Time control*.

Password

Under Password the password is defined for the application's different access levels. See the chapter *Password*.

Message library

Under Message library you create message tables where values between 0 and 65535 are linked to texts. See the chapter *Message library*.

5.16 The Setup Menu

Functions for configuration of the terminal are to be found in the **Setup** menu.

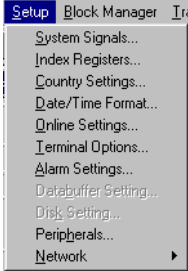

System signals

Setting of the handshaking signals between the terminal and the PLC system.

Current display reg.:

Register in the PLC system which contains the number of the block shown on the display in the run-time mode. The register is updated automatically by the terminal on changing block. This register does not affect the choice of text block.

New display reg.:

A PLC register that determines which block will be shown on the display.

Buzzer signal:

Not valid in E50, E100 and E200. A register whose value decides the sound of the buzzer. See the table below. If the value is 0 then the buzzer is silent. The unit in the table is Hz.

	C	D	E	F	G	A	B
Contra	33	37	41	44	49	55	62
Large	65	73	82	87	98	110	123
Small	131	147	165	175	196	220	247
One	262	294	330	349	392	440	494
Two	523	587	659	698	784	880	988
Three	1046	1174	1318	1397	1568	1760	1975
Four	2093	2348	2636	2794	3136	3520	3950
Five	4186						

Backlight signal:

Digital signal which determines if the display is to be switched on or off.

Cursor ctrl. block:

Not valid for E50, E100 and E200.

Start register to a control block in the terminal which writes the current cursor position in the graphic block to the register in the PLC system.

Register	Description
0	Current graphic cursor position X (in pixels), 0-239 in E300 and E600 and 0-319 in E700.
1	Current graphic cursor position Y (in pixels), 0-63 in E300, 0-127 in E600 and 0-239 in E700.
2	Status register 0 Normal 1 User trying to move down but there is no object there. 2 User trying to move up but there is no object there. 3 User trying to move left but there is no object there. 4 User trying to move right but there is no object there.

Start register to a control block in E710 which writes the current touch position in the graphic block to the register in the PLC system.

Register	Description
0	X-coordinate (in pixel), 0-319
1	Y-coordinate (in pixel), 0-239
2	Status register 0 Not pressed 1 Pressed

Recipe ctrl.block:

Control block for loading/saving/deleting of recipe files via the PLC system. See the chapter *Recipes*.

Current recipe reg:

State the first of four 16-bit registers where the terminal put the name of the last loaded recipe from the system. The name can be presented in an ASCII object. The function takes four registers (eight characters) independent of the recipe name.

Library index reg:

Used for indexing message libraries. In the Message object you state the number of the library from which the texts are loaded. If a index register is defined, the content of the index register are added to the stated number in the object. This make it possible to control from which library the texts are loaded from.

Commands

One or more of the following commands can be stated on the command line. The commands are separated by a space. E50 only support the commands R and T.

Command	Description
BR	Batch Read. Puts the terminal in transparent mode communication when using MELSEC PLC systems.
DGP	Delete the alarm group name from the alarm print out.
DD	Disable Delete alarms in the alarm list. When stated it is not possible to delete inactive and acknowledged alarms from the alarm list.
NTGL	Only valid for E100. Gives the NUM key toggle function. The NUM key activate/inactivate the function for entering numerical characters in E100.
NTx	Timeout in ms for messages in the No protocol mode.
PDxxxxxxx	Password xxxxxxxx that protect the transfer menu. Not valid in E100 and E200.
PSxxxxxxx	Password xxxxxxxx that will give access to all functions in the terminal. Not valid in E100 and E200
RPD	RUN/PROG disable. Turns off the possibility to switch between RUN/PROG with the keys [BACKSPACE] and [MAIN]. If RPD is used you switch mode via the MAC Programmer+.
Rx	Maximum number of retransmissions. x = number of attempts.
SW	Converts text with Swedish ASCII (7 bits) characters to 8 bits IBM PC extended ASCII on printing.
Tx	Global timeout for x milliseconds.
BFF	Block Form Feed. Puts a form feed after each block at print-out.
BSD	Baud Switching Disable when communicating via transparent mode with FX2N and Q. BSD must be set in the terminal not connected to the PLC system.
AKMx	Aktivates the joystick function, see the section “Joystick” function”
DIMDx	Data register containing a value between -63 and +63 controlling the display brightness. -63 means that the display is as dark as possible and +63 means that the display is as bright as possible. Normal value is 0.

Index register

Index addressing of dynamic objects. For more information see the *Index addressing* chapter.

Country settings

Language:

Choice of system message language during run-time in the terminal; *British English, German, Swedish or American English*. The default setting is English menu texts.

Character set:

The choice of character set affect the used font table in the terminal and which national characters that will be used.

Character set	Font table in graphic based terminals
Swedish	437
German	437
French	850
Spanish	850
Norwegian/Danish	850
Russian	866 Not E100 and E200
Slavic	852 Not E100 and E200

In the text based terminals E50, E100 and E200 special font tables is used and the same font table is used independent of the chosen character set. See appendix for all font tables.

Different national characters (see the section The terminals keyboard in the the chapter *Terminal functions*) are used dependent of the chosen character set.

	Swedish	German	French	Spanish	Nor/Dan
C1	Å	Ü	È	Ñ	Å
C2	Ä	Ä	É	É	Æ
C3	Ö	Ö	Ê	Ó	Ö
C4	å	ß	è	Á	Ø
C5	ä	ü	é	ñ	å
C6	ö	ä	ê	é	æ
C7		ö		ó	ö
C8		ß		á	ø

When Slavic or Russian are chosen the national characters are not used.

Date/Time format

Setting of date and time format.

Date format:

The default format can be YY-MM-DD, YYMMDD, DD.M.YY, DD/MM/YY or MM/DD/YY where Y=year, M=month and D=day.

Time format:

The default format can be HH:MM:SS or HH:MM where H=hour, M=minute and S=second.

Clock used:

Select Terminal or controller. Terminal means that the terminal's built-in clock is used and controller means that the clock in the controller system is used in the terminal.

Clock → Controller:

Only valid if the clock in the terminal is used. Mark if the clock in the terminal is to be transferred to the controller system.

Note!

If the controller system has a real-time clock that is activated and the terminal clock is transferred to the same registers in the controller system is using, the clock in the controller system is superior.

Update interval:

State how often the terminal will transfer the clock data to the controller system. The value is entered in seconds and 60 is recommended. A shorter updating interval makes the communication between the terminal and the controller system slower.

Controller register:

Enter the first address of the registers that will be used to store date and time in the controller system.

Controller:

Settings controller system MELSEC A series.

Data register	8 highest bits	8 lowest bits
D9025	year	month
D9026	day	hour
D9027	minute	second
D9028	–	weekday

Settings PLC system MELSEC FX series.

Data register	Presentation
D8013	second
D8014	minute
D8015	hour
D8016	day
D8017	month
D8018	year
D8019	weekday

If an other driver then MELSEC is used, see the manual to the PLC system how the date and time are stored. The terminal store the information in the same order as the default settings for the PLC system.

Daylight saving:

The beginning and end of summer or daylight saving time is defined here. State the day of the week, week in the month, month or hour. The default setting in the MAC Programmer+ is selectable between Europe and the US.

If you dont want to use Daylight saving time, leave the two fields for month empty.

Online settings:

Allow change of selected function in Run-time mode.

Terminal options

Screen save time:

The time in minutes after the last operation on the display when it will switch off. The default setting is 10 minutes. This function is used to optimize the display's working life. Also see the section Backlight action in the chapter Alarm handling.

Key delay time:

The time interval between pressing the same key before the cursor moves to the next position. Used for input of ASCII characters (A-Z etc.). See the section Alpha/numerical keys in the chapter *Terminal functions*.

Key beep:

States whether the terminal will beep when a key is pressed.

Key repeat:

States whether the numerical keys, arrow keys and built-in function keys are to be repeated as long as the key is pressed. Function keys and input of ASCII characters (A-Z etc) can not be repeated.

Background:

Select terminal background color in the list of choices by clicking BG.

Foreground:

Select terminal text color in the list of choices by clicking FG.

Window:

Select the color of the windows shown on the display by clicking Windows.

Trend settings

Select to store only samples in trends if the value has change since the last sampling.

Store all samples

Select to store all samples in trends even if the value has not change since the last sampling. The parameters are valid for all defined trends.

Alarm settings

General setting of the alarm list. For more information see the section on *Alarm handling*.

Peripherals

All communications configurations are made under **Peripherals**. When you select Peripherals the following is displayed. The display shows the units defined for the system. You can drag and drop the units.

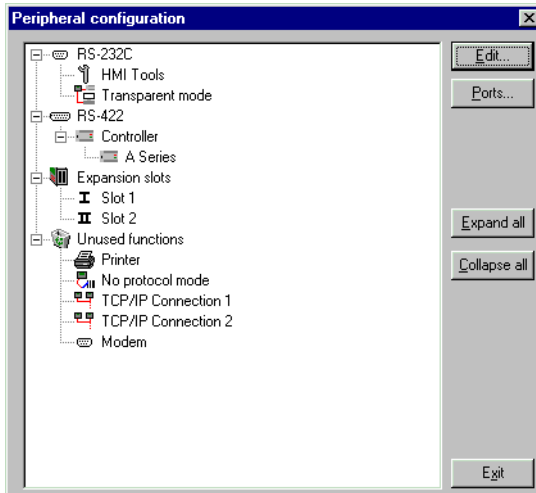

Edit...

You can mark a unit or a port on the display and press **Edit...** or click the right mouse button. Then the dialog for the selected unit/port is displayed.

Ports...

When you select **Port...** or click the right mouse button a dialog is displayed where you can see current configurations. The configurations can also be changed here.

RS-232C

When you select the **RS-232C** port and press **Edit...** or click the right mouse button the following dialog is displayed. You select baudrate, parity, number of data bits and stop bits for the port. To use RS-232C on E50 you must connect an adapter to the RS-422 port.



RS-422

When you select the **RS-422** port and press **Edit...** or click the right mouse button the following dialog is displayed. You select baudrate, parity, number of data bits and stop bits for the port.



Note!

The highest baudrate when using E50 or E100 is 38400 baud.

Expansion slot

When you select an **Expansion slot** and press **Edit...** or click the right mouse button you can define which expansion card you want to use and then make the the settings for the expansion cards respectively. For further information, see the manuals for the respective cards.

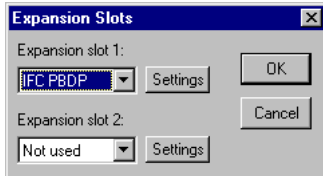

Printer

When you select **Printer** and press **Edit...** the dialog for printer settings is displayed.

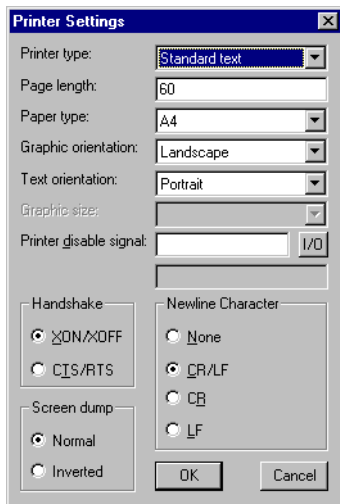

Printer type:

Select printer, None or e.g. HP PCL5.

Page length:

The number of lines which will be printed out before form feed. If the page length is set to 0 form feed never occurs. Default setting is 60.

Paper Type:

Select type of paper.

Graphic orientation:

Select the graphics orientation, portrait or landscape

Text orientation:

Select text orientation, portrait or landscape.

Graphic size:

Select size of the graphic printout.

Printer disable signal:

Digital signal for stopping the print out

Newline character:

Marks the required new line character; CR/LF, CR, LF or none.

Handshake:

Marks the required type of handshaking between the printer and the terminal; XON/XOFF or CTS/RTS. Refer to the printer manual for information about suitable handshaking.

Screen dump:

Printout of the screen. Select normal or inverted printout.

Note!

The settings on the printer is used for parameters such as character set, character size and margins.

No protocol mode

When you select **No protocol mode** and press **Edit...** or click the right mouse button the following dialog is displayed.

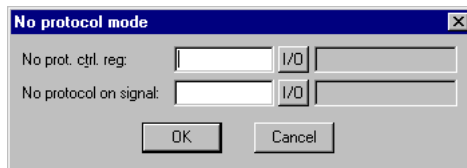
**No prot. ctrl. reg.:**

The first control register used in the No protocol mode. The No protocol mode is described in chapter *Communication*.

No protocol on signal:

A digital signal for switching between No protocol and Transparent modes. Used for switching between No protocol and Transparent modes in run-time mode e.g. to ring up a computer and send a message.

5.17 The Block Manager Menu

The **Block Manager** menu has functions for creating blocks and block-jumps.

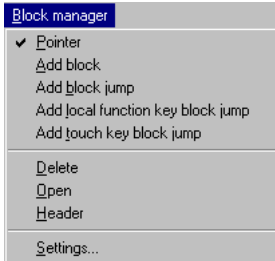

5.18 The Transfer Menu

The Transfer menu has functions for the transfer of projects as well as communication settings for transferring between a PC and the terminal. See the chapter *Transferring project*.



Note!

The communication settings must be the same in the MAC Programmer+ as in the terminal.

5.19 The Window Menu

In the window menu there is basic functions for windows and functions unique for MAC Programmer+. Here we describe only the functions special for MAC Programmer+.

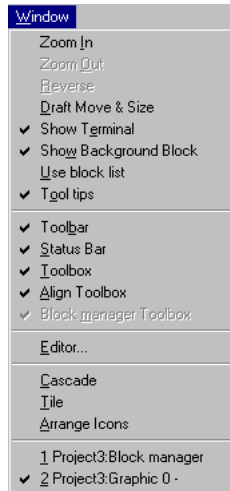

Draft Move & Size

The function turns of the immediate updating of the sized/moved object.

Show Terminal

A terminal is drawn around the working area in the graphic block editor. From this drawn terminal you can reach the editors for defining LEDs, function keys and insertable text strings. When you double click on the respective function the corresponding dialog is displayed.

Show Background block

Only valid for graphic block. Background block is shown when editing in the graphic block editor.

Use Block list

You can select if the software shall activate the block manager or the block list when you create a new project.

Tool tips

Show describing text for the function the cursor are pointing at.

Use terminal font

The character set defined in Country settings in the Setup menu is used in MAC Programmer+. This make it possible to edit e.g. russian projects without a russian version of Windows.

Toolbar

Show the toolbar.

Status Bar

Show the status bar

Toolbox

Show the toolbox.

Align Toolbox

Show the align toolbox.

Block Manager toolbox

Show the toolbox for the block manager.

Editor

Open stated graphic editor.

5.20 The Help Menu

The **Help** menu contains help texts.

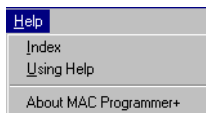

6 Graphic presentation and maneuvering

This chapter is not valid for E50, E100 and E200.

In this section the graphic objects are first presented in tabular form and each object is then described.

6.1 General parameters

Colors

In terminals supporting colors there are 16 colors available for objects, black, red, prussian blue, magenta, yellow, gray, light gray, light green, light red, light prussian blue, light magenta, light yellow and white. Bit-maps can be shown in 256 colors

The colors allow the creation of more realistic objects with 3-D effects and shadowing. Apart from background and foreground colors for the blocks, the colors can also be selected for the graphic objects.

The colors for the background, text and windows are determined when the terminal is configured. Colors can be chosen for example for the scales and curves for graphic objects.

Scaling

The *Offset* and *Gain* parameters are used to change the scale of the register value to a shown value according to the following equation:

$$\text{DisplayValue} = \text{Offset} + \text{Gain} * \text{RegisterValue}$$

When the object is altered from the terminal in the run-time mode, the scale is changed for the shown value according to the following equation:

$$\text{RegisterValue} = (\text{DisplayValue} - \text{Offset}) / \text{Gain}$$

Scaling does not affect the defined max and min values nor the number of decimal places.

Note!

The functions Increment and Decrement affect the RegisterValue of the maneuverable object, and not the DisplayValue.

Offset and Gain calculation

The function **OGC** in MAC Programmer+ is an aid for calculating the Offset and Gain parameters. Enter the max and min values for the PLC register and the max and min values for the presented value. The function will then calculate the correct value of the parameters Offset and Gain.









6.2 Graphic objects

Static graphic objects

Static graphic objects are used to draw graphics which are not affected by the process.

Note!

Static object will always be drawn behind dynamic objects in run-time mode.



Symbol	Object
	Arc
	Ellipse, filled
	Line
	Polygon line
	Rectangle, filled, 3-D
	Key field object
	Symbol
	Text

Dynamic digital graphic objects

Dynamic digital graphic objects are linked to digital signals in the PLC system.

Note!

It is not allowed to place dynamic objects on top of each other.





Symbol	Object	Description
	Digital symbol	Switch between two symbols depending on the state of a digital signal.
	Digital text	Switch between two texts depending on the state of a digital signal.
	Filled object	Used to fill in a framed area in one of two colors depending on the state of a digital signal.









Dynamic analog graphic objects

Dynamic analog graphic objects are linked to the registers in the PLC system.





Note!

It is not allowed to place dynamic objects on top of each other.

Symbol	Object	Description
	ASCII	Handle ASCII strings in Graphic blocks.
	Analog fill	Used to fill in a framed area in one of sixteen colors depending on the value of a register.
	Diagram	Used to draw X/Y diagrams based on the content of the PLC registers.
	Multichoice	Linked to a PLC register which can assume up to eight different states. Text of up to 30 characters can be linked to each state.
	Multisymbol	Shows one of up to eight symbols depending on the value in the PLC register. Also allows moving of a symbol across the screen.

Symbol	Object	Description
	Numeric	Entering and presentation of values as numbers
	Slide	Makes possible the increasing and decreasing the value of an analog signal.
	S meter	Creates a graphic speedometer on the display.
	Bar	Presents values in as a bar chart.
	Trend	Presents values collected from the registers as a curve.
	VU meter	Creates a graphic VU meter on the display.
	Message	Used to display texts from a Message library.
	Analog numeric table	Creates a table with numeric objects.
	Touch key	Only E710. Used to create a pressure-sensitive surface on the screen.

Other objects

Symbol	Object	Description
	Jump	Jump to another block.
	Alarm banner	Used to show a line in the alarm list.
	Digital clock	Object to show a digital clock.
	Analog clock	Object to show an analog clock.
	TCP/IP Command prompt	Object to send TCP/IP commands to other units. Only valid if the terminal is used in a TCP/IP network.



Alarm banner

Object used to show a line in the alarm list.



Parameter	Description
List line number	States the number of the line in the alarm list from which information is to be collected (1=first line, 2=second line etc.) if the stated alarm group is shown in the alarm list.
Positions	The number of positions to be displayed.
Font size	Select font size for the text in the object.
Alarm group	States which alarm group will be shown on the alarm line. The object will be shown in the color specified for the alarm group.
Security level	Select security level for the object.
Show day of the week	Select whether the day of the week will be shown in the alarm line.
Show date	Select whether the date will be shown in the alarm line.
Show time	Select whether the time will be shown in the alarm line.
Show symbol	Select whether the alarm status symbols will be shown in the alarm line. See the chapter <i>Alarm handling</i> .
Ack possible	Select whether it will be possible to acknowledge the alarm with the ACK key on the terminal.
Frame	Select if a frame shall be drawn around the object.
BG	Select background color for the object.

Note!

The foreground color of the alarm text is defined in the alarm group definition.



Analog clock

Time object for presenting an analog clock.

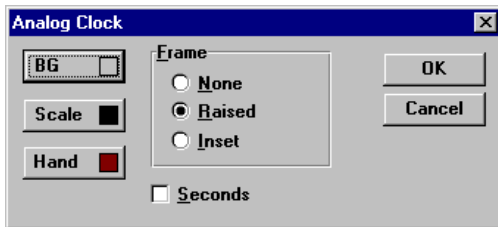
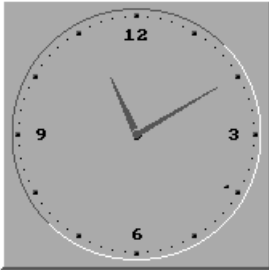

Parameter	Description
Seconds	Select whether the clock will be shown with a second hand.
Frame	Select whether the clock shall be shown with a frame.
BG	Select background color for the object.
Scale	Select the color of the scale in the object.
Hand	Select the color of the second hand in the object.

Note!

A maneuverable Date/Time object must be defined to set the clock in the terminal during run-time.



Analog fill

Objects used for filling framed areas with one of sixteen colors depending on the value in a register. The colors are used according to the following table.

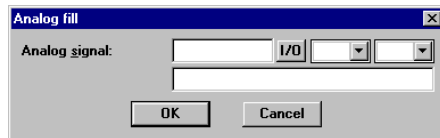
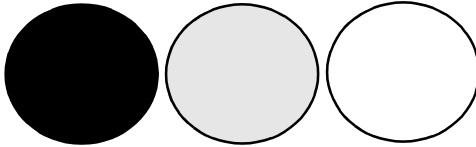

Parameter	Description
Analog signal	State the register whose value decides the color of the object. See the following table.

Register value	Color	Register value	Color
0	Black	8	Grey
1	Blue	9	Light blue
2	Green	10	Light green
3	Cyan	11	Light cyan
4	Red	12	Light red
5	Magenta	13	Light magenta
6	Yellow	14	Light yellow
7	Light grey	15	White

For limitations and how to place an object see *Digital fill*.



ASCII

Object for handling ASCII strings in Graphic blocks. ASCII objects provide the opportunity to present texts stored in the CPU's data registers. The texts should be in IBM extended ASCII format. The text is converted from 8-bit IBM extended ASCII to Swedish 7-bits ASCII if SW is stated on the command line in System Signals.

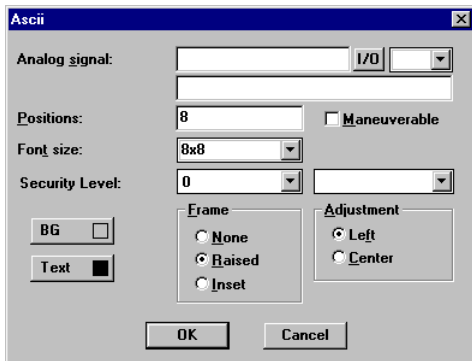

Parameter	Description
Analog signal	State the register where the text for the first position is to be stored.
Positions	State the number of positions the text will occupy on the display. Each register contains two characters (occupying two positions).
Font size	Select font size.
Security Level	Select security level for the object.
Maneuverable	When selected the object can be forced from the terminal in runtime mode.
Adjustment	Select whether the object is to be left aligned or centred.
Frame	Select if a frame shall be drawn around the object.
BG	Select background color of the object.
Text	Select the color of the text in the object.

 **Bar**

Objects which present whole or decimal numbers in the form of a bar graph.

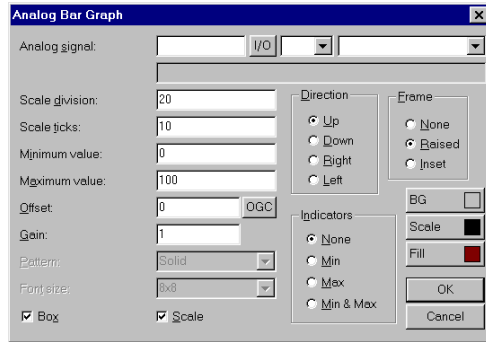
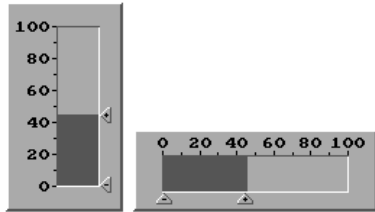

Parameter	Description
Analog signal	The address of the signal.
Minimum value	The minimum value the signal can have.
Maximum value	The maximum value the signal can have.
Direction	Select whether the bar is to be shown to the right, left, up or down.
Scale	Select whether the scale is to be shown.
Box	Select whether a box is to be drawn around the bar.
Indicators	Select whether the highest and/or the lowest value for the signal shall be shown on the axis. Indicators are set to zero when the terminal is switched on. Zeroing can also be carried out in the run-time mode, see the Maneuvering Graphic blocks section. The indicators only function for 16-bit numbers.
Scale division	State the interval between the scale numbers to be drawn.
Scale ticks	State the interval between the scale ticks displayed.
Fill	Select fill color.
Offset and Gain	Used to scale register value. See the section General parameters.
Frame	Select if a frame shall be drawn around the object.
BG	Select background color for the object.
Scale	Select the color of the scale in the object.



Diagram

Objects used to draw X/Y diagrams or bar graphs based on the content of the PLC register. This is a real-time function. The object is normally used for non-time-based presentations. Time-based display with a sample time of <1 second can be shown if the PLC creates data collection. As an example we shall say the value in data register 100 is the first X-coordinate and the value in data register 200 the first Y-coordinate. The number of register pairs will be 4. The table and the figure below illustrate our example.

X-coordinate	Register	Value	Y-coordinate	Register	Value
X0	100	0	Y0	200	11
X1	101	41	Y1	201	40
X2	102	51	Y2	202	85
X3	103	92	Y3	203	62

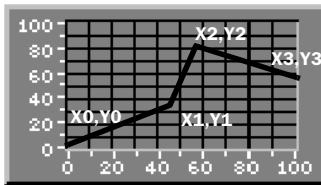

Diagram *

Curve:

Register pair count:

Maneuverable

X Analog signal: I/O

Y Analog signal: I/O

Graph name:

Y-axis: Scale division: Scale ticks: Minimum value: Maximum value:

X-axis: Scale division: Scale ticks: Minimum value: Maximum value:

Diagram maneuver:

Current graph signal: I/O

Current cursor signal: I/O

X Edit step:

Y Edit step:

Value form: Line Bar

Eframe: None Raised Inset

Grid

Font size:

Thickness: Thin Thick

BG:

Scale:

Grid:

Parameter	Description
Register pair count	The number of register pair to be drawn as dots or bars for the curve respective.
Value form	Select whether the diagram shall be a bar graph or linear graph for the curve respective. A bar is drawn for each register pair in the bar graph. The X/Y coordinates are marked in as dots between which a line is drawn in a linear graph.
Curve	Select the color of the curve respective.
X Analog signal	The PLC register which contains the first X-coordinate for the curve respective.
Y Analog signal	The PLC register which contains the first Y-coordinate for the curve respective.
Y Scale division	The interval between the scale number on the Y-axis.
Y Scale ticks	The interval between the scale ticks displayed on the Y-axis.
Y Minimum value	The minimum value of the Y-coordinate.
Y Maximum value	The maximum value of the Y-coordinate.
X Scale division	The interval between the scale number on the X-axis.
X Scale ticks	The interval between the scale ticks displayed on the X-axis.
X Minimum value	The minimum value of the X-coordinate.
X Maximum value	The maximum value of the X-coordinate.
Frame	Select if a frame shall be drawn around the object.
Grid	When selected the grid is drawn in the diagram.
BG	Select background color of the object.
Scale	Select the color of the scale for the object.
Grid color	Select the color of the grid in the diagram.

Digital Clock

Time object for presenting a digital clock.

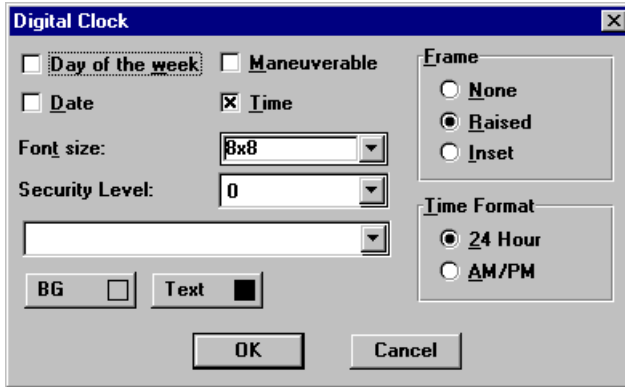
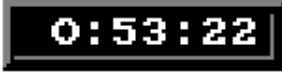

Parameter	Description
Day of the week	Select whether the day of the week will be shown.
Date	Select whether the date will be shown.
Time	Select whether the time will be shown.
Time format	Time can be shown either as AM/PM or a 24-hour clock.
Maneuverable	Select whether the clock can be reset in run-time mode.
Frame	Select if a frame shall be drawn around the object.
Font size	Select font size for the text in the object.
Security level	Select security level for the object. 0 means no security level.
BG	Select background color.
Text	Select the color of the text in the object.

Note!

A maneuverable Date/Time object must be defined to set the clock in the terminal during run-time.



Digital fill

Objects used for filling framed areas with a selected color.

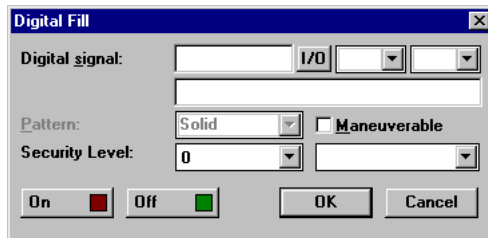
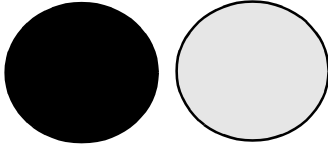

Note!

Filling areas that are too irregular can cause system failure in run-time mode. Filling can, in certain cases, make the screen slow.

Parameter	Description
Digital signal	The address of the digital signal.
Maneuverable	When selected the object can be forced from the terminal in run-time mode.
Security Level	Select security level for the object.
On	Select the color of the object when the signal is 1.
Off	Select the color of the object when the signal is 0.

Placing an object

The program calculates what is to be filled in the specified area. It's therefore important that the object is correctly placed. Wrong placed fillers may cause errors in the application during run-time. The filled area is limited only by static objects and static parts of dynamic objects. Fill objects can be replaced with Digital Symbol or Multi Symbol to give better performance to the project.

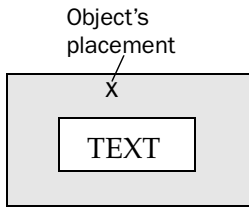

Good! To give the display better response, frame the text so it does not need to be filled.

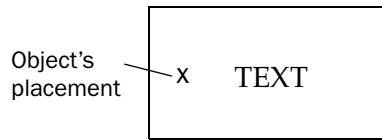

Bad! The display will be slow, because the program must make many calculations to fill in the irregular areas between letters.



Digital symbol

Object which is used to switch between two chosen symbols depending on the state of a digital signal.

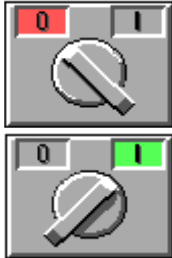

Digital Symbol

Digital signal: [] I/O [] []

Symbol OFF: [] Maneuverable

Symbol ON: []

Security Level: 0 []

[]

OK Cancel

Parameter	Description
Digital signal	The address of the signal.
Symbol OFF	Select the symbol which is to be shown when the signal is 0.
Symbol ON	Select the symbol which is to be shown when the signal is 1.
Maneuverable	When selected the object can be forced from the terminal in runtime mode.
Security Level	Select security level for the object. 0 means no security level.



Digital text

Text object which is used to switch between two entered texts depending on the state of a digital signal. The maximum text length is 30 characters.

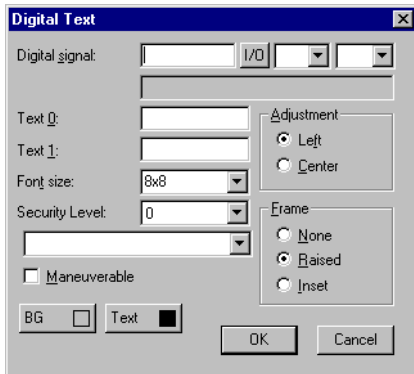

Parameter	Description
Digital signal	The address of the digital signal.
Text 0	The text which is to be shown when the signal is 0.
Text 1	The text which is to be shown when the signal is 1.
Font size	Select font size.
Security Level	Select security level. 0 means no security level.
Maneuverable	When selected the object can be forced from the terminal in run-time mode.
Adjustment	Select whether the text is to be left aligned or centred.
Frame	Select if a frame shall be drawn around the object.
BG	Select background color of the object.
Text	Select text color in the object.



Jump

Object for jumping to another block. Makes it possible to build up a hierarchy of menus in the application. Jumping back to the previous block is done by pressing the [PREV] key (up to nine levels back). See chapter *Function Keys*.



Parameter	Description
Jump to block	States the number of the block to which the jump is to be made.
Text	Enter any text that will be displayed.
Positions	The number of positions the text will take up on the display.
Font size	Select font size.
Adjustment	Select whether the text shall be left aligned or centred.
Frame	Select if a frame shall be drawn around the object.
BG	Select background color for the object.
Text	Select the color of the text in the object.

Note!

If a jump is generated to a block that does not exist in run-time mode an error message is shown.



Message

Message object presenting texts from message libraries.

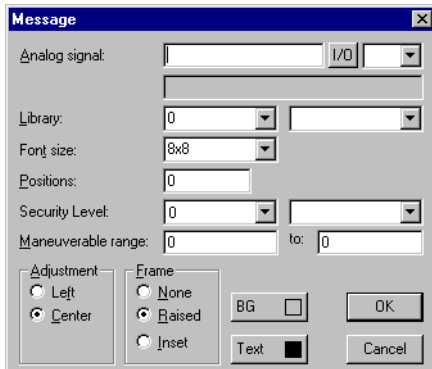

Parameter	Description
Analog signal	Analog signal controlling which text from chosen message library to be shown.
Library	Select the number of a message library. Defined under Message Library in the Function menu.
Font size	Select font size of the text.
Positions	Number of positions to be displayed. 0=automatic adjustment
Security level	Select security level for the object. 0 means no security level.
Maneuverable range	A range of maximum 64 texts can be maneuverable in run-time mode. State the numbers of the first and the last texts of the range. See the section <i>Maneuvering Graphic Blocks</i> .
Adjustment	Select if the text shall be left aligned or centred.
Frame	Select if the text shall be displayed with a frame.

Note!

When using Library index register the number of positions should not be 0 since the automatic length adjustment doesn't work.

For more detailed information, see the chapter *Message library*.



Multiple choice

Objects that can have several states. The object is linked to a register which can assume a maximum of eight states. Each state can be allocated a text, maximum 30 characters long.



Parameter	Description
Analog signal	The register that decides which text that is to be displayed.
Text 0-7	The texts which are to be shown for each state of the object.
Man 0-7	When selected the object can be maneuvered to this state in run-time mode. See the section Maneuvering Graphic Blocks.
Adjustment	Select whether the text shall be left aligned or centred.
Frame	Select if a frame shall be drawn around the object.
Font size	Select font size in the object.
Security Level	Select security level for the object.
BG	Select background color for the object.
Text	Select the color of the text in the object.



Multisymbol

Objects that can show one of a maximum of eight different symbols depending on the value in a data register. The PLC register can also control the symbol's location on the display.

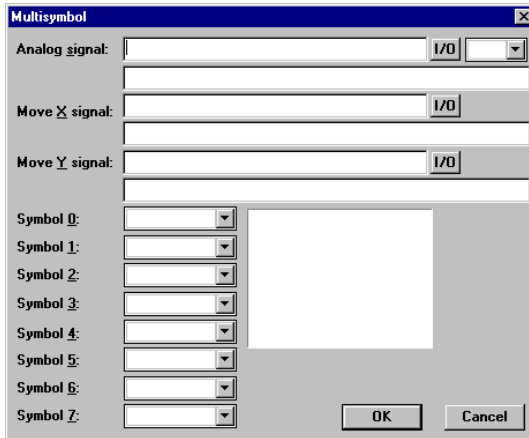

Parameter	Description
Analog signal	The register that decides which symbol to be displayed. If the register contains the value 1 symbol 1 is displayed etc.
Move X	The value which contains the X-coordinate for the object. Permissible values are 0-239 for E300, 0-239 for E600 and 0-319 for E700/E710.
Move Y	The value which contains the Y-coordinate for the object. Permissible values are 0-63 for E300, 0-127 for E600 and 0-239 for E700/E710.
Symbol 0-7	Select the symbol to be displayed. If the value of the register is 0, then symbol 0, is displayed etc.

Note!

Move X and Y only need to be stated if the object is to be moved around on the display with the help of the PLC.

0.3 Numeric

Objects for entry and presentation of values in numerical form. It is used for example to create entry fields.



Parameter	Description
Analog signal	The address of the signal.
Positions	The number of positions the entered value will take up including comma and minus sign.
Decimals	The number of decimals the value shall be entered with.
Minimum value	The minimum limit for maneuvering.
Maximum value	The maximum limit for maneuvering.
Offset and Gain	Used to scale register value. See the section General parameters.
Font size	Select font size in the object.
Security Level	Select security level for the object.
Adjustment	Select if the input field shall be left aligned or centred.
Frame	Select if a frame shall be drawn around the object.
Maneuverable	Select if the object can be altered from the terminal in the run-time mode.
Zero fill	Select if zeros are to be printed out in empty positions.
BG	Select background color for the object.
Text	Select the color of the text in the object.



Numeric table

Not valid for E300.

Object for creating a table of analog numeric objects.



The dialog box 'Analog Numeric Table' includes the following controls:

- Analog signal:** Input field with 'I/O' dropdown and a secondary dropdown.
- X-size:** Input field with value '2'.
- Y-size:** Input field with value '2'.
- Positions:** Input field with value '5'.
- Decimals:** Input field with value '0'.
- Minimum value:** Input field with value '-32768'.
- Maximum value:** Input field with value '32767'.
- Offset:** Input field with value '0' and 'OGC' button.
- Gain:** Input field with value '1'.
- Font size:** Dropdown menu with '8x8' selected.
- Security Level:** Dropdown menu with '0' selected.
- Maneuverable:** Check box (unchecked).
- Zero fill:** Check box (unchecked).
- Direction:** Radio buttons for 'Vertical' and 'Horizontal' (selected).
- Table frame:** Radio buttons for 'None', 'Raised', and 'Inset'.
- Adjustment:** Radio buttons for 'Right' and 'Center'.
- BG:** Check box (unchecked).
- Text:** Color selection button (black).
- Item frame:** Radio buttons for 'None', 'Raised' (selected), and 'Inset'.
- Buttons:** 'OK' and 'Cancel'.

Parameter	Description
Analog signal	The first signal to be presented in the table. Only 16-bit registers can be used if version 4.0 or higher on the terminal is used.
X-size	State the number of signals to be presented horizontally.
Y-size	State the number of signals to be presented vertically.
Positions	The number of positions you should enter the value with including comma and minus sign.
Decimals	The number of decimals you should enter the value with.
Minimum value	The minimum limit for maneuvering.
Maximum value	The maximum limit for maneuvering.
Offset and Gain	Used to scale register value. See the section General parameters.
Font size	Select the size of the text in the object.
Security level	Select the security level for the object.
Maneuverable	Select whether the object can be altered in the run-time mode.

Parameter	Description
Zero fill	Select if zeros are to be printed out in empty positions.
Direction	Select direction for the object, horizontal or vertical. The signals in the table are calculated after this direction.
Table frame	Select whether the whole table shall be shown with a frame.
Adjustment	Select whether the entry field shall be left aligned or centred.
BG	Select background color for the object.
Text	Select the color of the text in the object.
Item frame	Select if every single item in the table shall be shown with a frame.

Note!

Minimum value and maximum value are only active when maneuvering the object.



Slide

Objects which make it possible to increase or decrease the value of an analog signal.

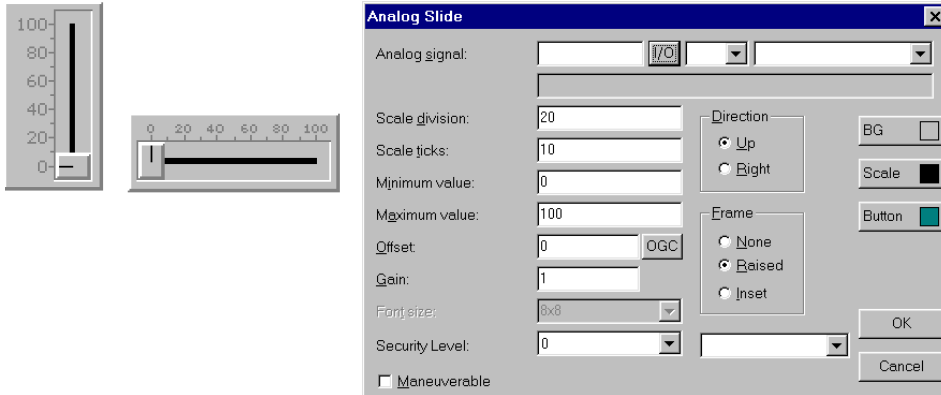

Parameter	Description
Analog signal	The address of the analog signal.
Scale division	State the interval between the scale numbers to be drawn.
Scale ticks	State the interval between the scale ticks displayed.
Minimum value	The minimum value the object can have.
Maximum value	The maximum value the object can have.
Offset and Gain	Used to scale register value. See the section General parameters.
Security level	Select security level for the object.
Maneuverable	Select whether the object can be altered from the terminal in the run-time mode.
Direction	Select whether the object shall be presented vertically or to the right.
Frame	Select if a frame shall be drawn around the object.
BG	Select background color for the object.
Scale	Select color of the scale in the object.
Button	Select color of the indication button in the object.

Note!

The data type formats BCD float and Float without exponent do not work for slide objects.



S-meter

Objects for creating a graphic speedometer on the display.

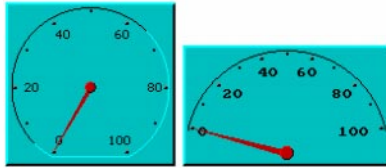

Analog Speedometer [X]

Analog signal: [] [I/O] [] []

Scale division: [20]

Scale ticks: [10]

Minimum value: [0]

Maximum value: [100]

Angle: [300]

Offset: [0] [OGC]

Gain: [1]

Font size: [5x5] []

Frame

None

Raised

Inset

BG

Scale

Needle

OK

Cancel

Parameter	Description
Analog signal	The address of the signal.
Scale division	State the interval between the scale numbers to be drawn.
Scale ticks	State the interval between the scale ticks displayed.
Minimum value	The minimum value the object can display.
Maximum value	The maximum value the object can display.
Angle	State the angle, working area, for the object. 10-360 degrees.
Offset and Gain	Used to scale register value. See the section General parameters.
Frame	Select if a frame shall be drawn around the object.
BG	Select background color for the object.
Scale	Select the color of the scale in the object.
Needle	Select the color of the needle in the object.



TCP/IP Command prompt

A window in which TCP/IP commands can be entered and sent between terminals and personal computers in a TCP/IP network. In run-time previous commands can be called up with the arrow keys [Up] and [Down].

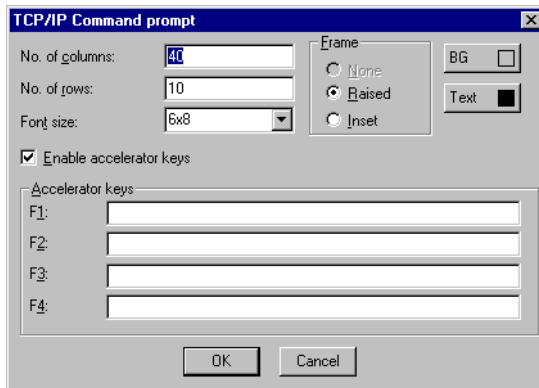

Parameter	Description
No. of columns	The width of the window.
No. of rows	The height of the window.
Font size	Select font size in the object.
Enable accelerator keys	Select whether the function keys F1-F4 should write predefined commands in the window.
Accelerator keys	Enter any command that will be written at the command prompt by pressing respective function key.
Frame	Select the type of frame the window will be shown with.
BG	Select background color for the window.
Text	Select the color of the text in the window.

Commands for the TCP/IP Command prompt

Command	Description
IPCONFIG	Gets network parameters/IP address
PING	Testing if a host is available
ROUTE	Show/Add/Delete routes
ARP	Show/Add/Delete IP/Hardware address

For further information about the TCP/IP network we refer to the chapter *Network communication*.



Touch key

Only valid for E710. See the section *Maneuvering Graphic Blocks*.

The object is a pressure-sensitive surface whose function corresponds to a function key. The object is used to change pictures, control digital signals and so on.

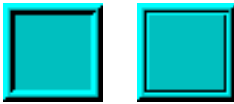

Parameter	Description
Action	The type of signal the object shall affect. Predefined functions are described in the chapter <i>Function keys</i> . Increment, Decrement and Set are not available.
Digital signal	The digital signal affected by the object if I/O is selected under Action.
Block	The block that will be displayed if the object is defined as an jump object if block type is selected under Action.
Security level	Select security level for the object.
Button type	Select required type of button, circular, rectangular or invisible.
IO event	States how the object shall affect the signal. Momentary means that the signal is affected as long as the object is touched. Toggle means that the signal is set to one or zero alternately when the object is affected. On means that the signal is set when the object is affected. Off means that the signal is reset when the object is affected.
BG	Select background color for the object.

An invisible, pressure-sensitive “virtual” surface can be used to define the area for block changes in an overview display of, for example, a machine. Detail images are linked to defined parts of the overview display. When the pressure-sensitive areas are pressed, the detail images appear.



Trend

Objects which graphically present collected values from analog signals.

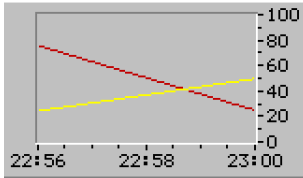

Trend	
Name:	<input type="text"/>
Curve:	<input type="text"/> <input type="button" value="1"/> <input type="button" value="2"/> <input type="button" value="3"/>
Analog signal:	<input type="text"/> <input type="button" value="I/O"/> <input type="button" value="Color"/> <input type="button" value="Color"/>
Offset signal:	<input type="text"/> <input type="button" value="0"/> <input type="button" value="DGC"/>
Gain signal:	<input type="text"/> <input type="button" value="1"/>
Enable:	<input type="text"/> <input type="button" value="I/O"/>
Y Min value reg:	<input type="text"/> <input type="button" value="I/O"/>
Y Minimum value:	<input type="text"/> <input type="button" value="0"/>
Y Max value reg:	<input type="text"/> <input type="button" value="I/O"/>
Y Maximum value:	<input type="text"/> <input type="button" value="100"/>
Y Scale division:	<input type="text"/> <input type="button" value="20"/>
Y Scale ticks:	<input type="text"/> <input type="button" value="10"/>
Font size:	<input type="text"/> <input type="button" value="5x5"/>
Y Value form:	<input type="radio"/> Linear <input type="radio"/> Logarithm
Y Scale:	<input type="radio"/> Off <input type="radio"/> Left <input checked="" type="radio"/> Right <input type="radio"/> Both
Frame:	<input type="radio"/> None <input checked="" type="radio"/> Raised <input type="radio"/> Inset
X Sample interval:	<input type="text"/> <input type="button" value="00:00:10"/>
X Stored samples:	<input type="text"/> <input type="button" value="100"/>
X Time range:	<input type="text"/> <input type="button" value="00:04:00"/>
X Time scale div.:	<input type="text"/> <input type="button" value="00:02:00"/>
X Time scale ticks:	<input type="text"/> <input type="button" value="00:00:30"/>
Sample full limit:	<input type="text"/> <input type="button" value="0"/>
Sample full signal:	<input type="text"/> <input type="button" value="I/O"/>
Grid:	<input checked="" type="checkbox"/> Grid
BG:	<input type="checkbox"/> BG
Scale:	<input type="checkbox"/> Scale
<input type="button" value="OK"/> <input type="button" value="Cancel"/>	

Parameter	Description
Name	State the name of the object. The name must be unique for each object.
Curve	Select the curve you want to edit 1-2 in E300, E600 and 1-6 in E700/E710.
Analog signal	The analog signals the object shall sample and present the values for. Only 16-bit numbers can be used. For valid devices see the driver manual.
Color	Select a color for each curve.
Offset and Gain	Used to scale register value. See the section General parameters.

Parameter	Description
Enable	The digital signal which when set starts the collection of data. Data collection ceases if the signal is set to zero. The parameter needs not be stated.
Y Min value reg.	The minimum value on the Y-axis loaded from the stated PLC register.
Y Minimum value	The minimum value on the Y-axis. (If Y Min value reg. is defined this is the minimum value that can be loaded from the register.)
Y Max value reg.	The maximum value on the Y-axis loaded from the stated PLC register.
Y Maximum value	The maximum value on the Y-axis. (If Y Max value reg. is defined this is the maximum value that can be loaded from the register.)
Y Scale	States which side of the Y-axis shall be shown, to the left, right, both or neither.
Y Scale division	The interval between the scale number on the Y-axis.
Y Scale ticks	The interval between the scale ticks displayed.
X Sample interval	States the time interval between the collection of data. Minimum value is 1 second and maximum value is 100 hours.
X Stored samples	States how many values shall be stored. The maximum number of values are 4800. Only valid in E700 and E710.
X Time range	States the time interval to be shown in the trend diagram.
X Time scale division	The interval between the scale number on the X-axis.
X Time scale ticks	The interval between the scale ticks displayed.
Sample full limit	State the number of samples when the samples full signal shall be set. Only valid in E700 and E710.
Sample full signal	Select a signal which will be set when the number of samples reach the value stated in the parameter Sample full limit. Only valid in E700 and E710.
Frame	Select if a frame shall be printed around the object.
BG	Select background color for the object.
Scale	Select the color of the scale in the object.
Erase trend data signal	The digital signal which when set will erase all historic trend data. Not valid in E300.
Grid	Select if grid shall be displayed in the object.
Grid color	Select a suitable color for the grid.

Note!

If you copy a block containing a trend object you must change the name of the trend object. Two trend objects may not have the same name.



VU-meter

Object for creating a graphic VU meter on the display.

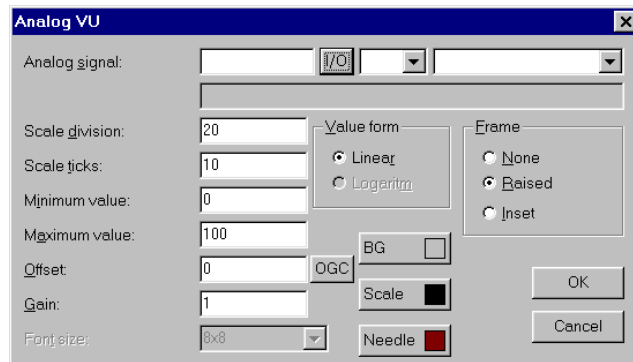
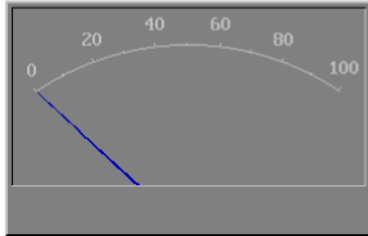

Parameter	Description
Analog signal	The address of the signal.
Scale division	State the interval between the scale numbers to be drawn.
Scale ticks	State the interval between the scale ticks displayed.
Minimum value	The minimum value the signal can have.
Maximum value	The maximum value the signal can have.
Offset and Gain	Used to scale register value. See the section General parameters.
Frame	Select if a frame shall be drawn around the object.
BG	Select background color for the object.
Scale	Select the color of the scale in the object.
Needle	Select the color of the needle in the object.

6.3 Maneuvering Graphic Blocks

Not valid for E710.

Move between the maneuverable objects with the arrow keys. Objects selected are highlighted with a blinking frame.

Selecting maneuverable objects

The arrow keys are used to jump between maneuverable objects in the terminal during run-time. The choice of object is according to the following principle: The cursor's position is assumed to be the center of a cross. Press the right arrow and the first object found in area A according to the diagram below is selected. Should the system not find an object in the narrow field on the right, it searches in area a. The down arrow searches in areas B and b, the left arrow searches in areas C and c and the up arrow searches in areas D and d.

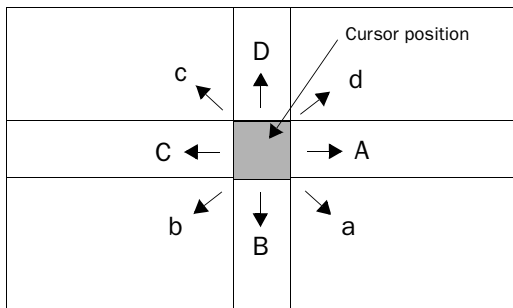

Digital objects

Digital objects, text, symbol and filled objects, switch status when [ENTER] is pressed. If the INC and DEC functions have been linked to function keys, the signal linked to the object with these keys is set and reset respectively.

Analog objects

ASCII objects

Mark the object and enter the required text. Finish writing with [ENTER].

Message objects

Place the cursor on the object and press [ENTER]. An option list is now shown with all the maneuverable states. Move stepwise to the required state and press [ENTER] and the analog signal linked to the object is forcibly set.

Multichoice objects

Place the cursor on the object and press [ENTER]. An option list is now shown with all the maneuverable states. Move stepwise to the required state and press [ENTER] and the analog signal linked to the object is forcibly set.

Numerical objects

To maneuver numerical objects write in the value and press [ENTER]. If a value too high or too low is entered the max and min value for the object is shown. This information will also be shown if you press [ENTER] when the object is maneuverable.

Numerical table objects

When the table object is marked press [ENTER] to select the first item in the table. Use the arrow keys to move the cursor between the items in the table. Change the value in the marked item and press [ENTER].

Potentiometer objects

The object is maneuvered with the arrow keys by placing the cursor on the object and pressing [ENTER]. The value can now be increased/decreased with the number that corresponds to the setting "Scale Ticks" in the object. End maneuvering with [ENTER].

The object can also be maneuvered with the Increment and Decrement functions on the condition that they are linked to the function keys, see the *Function keys* section.

Bar object

The min/max indicators for bar objects can be set at the current value by pressing [ENTER].

The max/min indicators are reset when you touch the bar.

Trend objects

Not valid in E50, E100, E200 and E300.

Trend curves can show historic data in the run-time mode. Mark the required trend object and press [ENTER]. A dialog square is now shown and the date for the data to be presented can be chosen. "History" is shown at the bottom of the square. Press [ENTER] again to return to real-time display. Trend data is stored in the files whose names are stated when the trend object is defined.

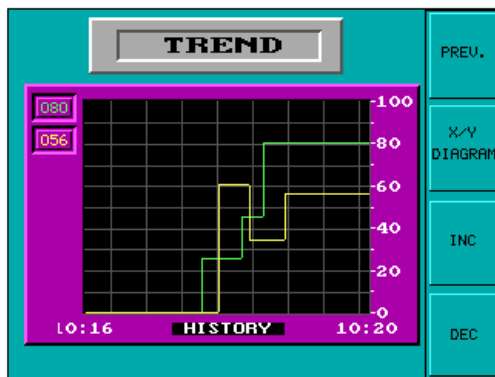

Trend History			
Left time	:	:	10:32:00
Right time	:	:	10:36:00
Left date	:	:	97-05-21
Right date	:	:	97-05-21

OK

Other objects

Digital clock

The digital clock can be altered by marking the object and giving the required time. Finish with [ENTER].

Note!

If you use the clock in the PLC system and you want to change it, this must be done in run-time mode.

Jump object

Mark the object and press [ENTER].

TCP/IP Command prompt

TCP/IP Commands can be written on the highlighted row. Previous commands can be called up by pressing the arrow keys [Up] and [Down].

6.4 Using the touch screen

This section is only valid for E710.

E710 does not have a built-in keyboard. All maneuvering takes place using the touch screen. Because of its sensitivity, you should only press one point on the screen at any given time. Otherwise, the terminal will interpret the midpoint of two points pressed.

Digital objects

Digital objects, text, symbol and filled object change status when you touch them.

Analog objects

ASCII objects

When you touch the object an alphanumeric keyboard will be shown on the screen. Touch in the required text and end with [ENTER].

Multichoice objects

When you touch the object a choice list appears. Select the required object by touching it.

Numerical objects

When you touch the object a numeric keyboard appears. Touch the new value and end with [ENTER].

Numerical table objects

When you touch the item in the table object a numeric keyboard appears. Touch the new value and end with [ENTER].

Potentiometer objects

Touch the button in the object and drag to maneuver the object.

Bar object

The max/min indicators are reset when you touch the bar.

Trend objects

Trend curves can show historic data in run-time. When you touch the object a dialog box appears where you can choose the time interval and date for presented data.

- | | |
|---------------|-----------------------------|
| Double arrow | Move the trend one window. |
| Single arrows | Move the trend 1/4 window. |
| - | Zoom up the trend. |
| + | Zoom down the trend. |
| ^ | Return to default settings. |

Return to realtime trend by touching the object again.

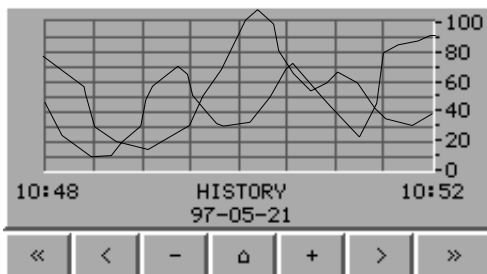

Other objects

Digital clock

When you touch the object a numeric keyboard appears. Touch the required time and end with [ENTER].

Note!

If you use the clock in the PLC system and you want to change it, this must be done in run-time mode.

Jump object

Touch the object to activate the jump.

Alphanumeric keyboard

The alphanumeric keyboard appears when you maneuver, e.g. an ASCII object.

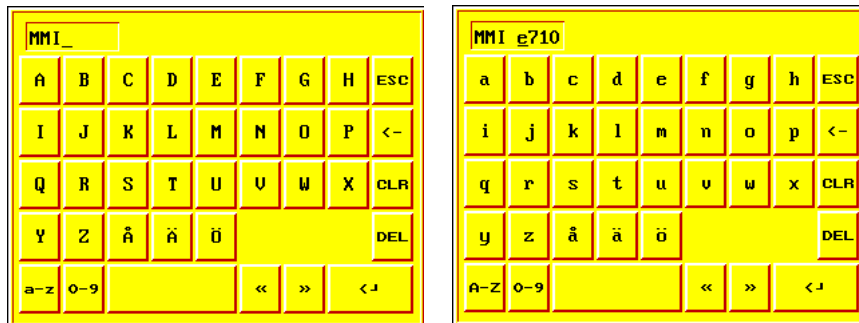

Key	Description
A-Z	Used to enter required text.
ESC	Close down the keyboard and return to previous level.
←	Delete one character to the left.
CLR	Delete all characters.
DEL	Delete the character on cursor position.
↵	Confirm the settings and close down the keyboard.
»	Move the cursor to the right.
«	Move the cursor to the left.

Key	Description
a-z	Switch between upper case and lower case letters.
0-9	Switch between lower case letters and digits and special characters.

Numeric keyboard

The numeric keyboard appears when you maneuver, e.g. a numeric object.

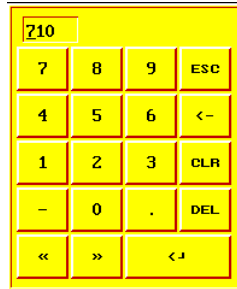
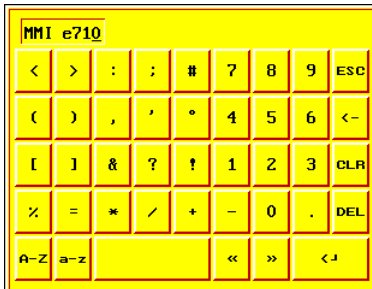

Key	Description
0-9	Used to enter required text.
ESC	Close down the keyboard and return to previous level.
<-	Delete one character to the left.
CLR	Delete all characters.
DEL	Delete the character at cursor position.
<↓	Confirm the settings and close down the keyboard.
>>	Move the cursor to the right.
<<	Move the cursor to the left.

Choice list

Choice lists will also appear on the screen. In the choice list you use the arrows to show the uppermost or lowermost choice respectively. [CANCEL] is used to close down the list without making a selection.



7 Text-based presentation and maneuvering

Text-based presentation and maneuvering is used to create operator dialogs in textbased terminals or is suitable for generating report print-outs of various kinds. They can be daily reports, status reports etc. For an example of what a report looks like see the *Print-outs* section. Text objects in tabular form are shown in this section. Every object is then described separately.

7.1 General parameters

Not valid for E50.

Scaling

The *Offset* and *Gain* parameters are used to change the scale of the register value to a shown value according to the following equation:

$$\text{DisplayValue} = \text{Offset} + \text{Gain} * \text{RegisterValue}$$

When the object is altered from the terminal in the run-time mode, the scale is changed for the shown value according to the following equation:

$$\text{RegisterValue} = (\text{DisplayValue} - \text{Offset}) / \text{Gain}$$

Scaling does not affect the defined max and min values nor the number of decimal places.

Note!









The functions Increment and Decrement affect the RegisterValue of the maneuverable object, and not the DisplayValue.

Offset and Gain calculation

The function OGC in MAC Programmer+ is an aid for calculating the Offset and Gain parameters. Enter the max and min values for the PLC register and the max and min values for the presented value. The function will then calculate the correct value of the parameters Offset and Gain.

7.2 Text object

Dynamic text object

Symbol	Object	Description
	Analog	Presents values in numerical form.
	Date/time	Setting of date and time.
	Digital	Switch between two texts depending on the state of a digital signal.
	Multiple-choice	Links to a PLC register which can assume up to eight different states. A text of 30 characters can be linked to each state.
	Jump	Jump to another block.
	Bar graph	Presents values as a bar graph.
	Text	Handles ASCII strings.
	Message	Object showing texts in a message library

0.3 Analog object

Object which presents values in numerical form as whole or decimal numbers.

Parameter	Description
Analog signal	The address for the signal.
Positions	The number of positions used by the object. Characters such as minus sign or decimal points must also be counted.
Decimals	The number of decimal places which represent the object.
Maneuverable	States if the object can be altered in run-time.
Minimum value	The minimum value you can enter for an object.
Maximum value	The maximum value you can enter for an object.
Offset and Gain	Used to change scale of the register value. See the section General parameters.

Note!

Minimum value and maximum value is only valid when maneuvering the object.



Bar graph object

Not valid for E50.

Presents values in the form of a bar graph. The bar will be horizontal so that the maximum number of positions are marked when the value has reached its maximum level.

Parameter	Description
Analog signal	The address for the signal.
Positions	The number of positions which the signal uses.
Direction	States whether the bar will be presented to the right or left.
Minimum value	The minimum value for the object.
Maximum value	The maximum value for the object.
Offset and Gain	Used to change scale of the register value. See the section General parameters.

Date/time object

Not valid for E50.

Object for setting date and time. Date and time objects collect data from the real-time clocks in the terminal or the controller system.



Parameter	Description
Day of the week	States if the day of the week will be shown. Requires two positions.
Date	States if the date will be shown. Use the form given in Date/time format in configuration.
Time	States if the time will be shown. Use the form given in Date/time format in configuration.
Maneuverable	Select if the object can be altered in run-time mode.

Note!

A maneuverable Date/Time object must be defined to set the clock in the terminal during run-time.



Digital text

Object that can assume two states, zero or one.

Parameter	Description
Digital signal	The address for the signal.
Text 0	The text shown when the signal is zero.
Text 1	The text shown when the signal is one.
Maneuverable	Select if the object can be altered in run-time mode.



Jump object

Object for jumping to another block. Makes it possible to build up a hierarchy of menus in the application. Jumping back to the previous block is done by pressing the [PREV] key (up to nine levels back). See chapter *Function Keys*.

Parameter	Description
Current block	States the number of the block left.
Jump to block	States the number of the block to which the jump is to be made.

Note!

If a jump is generated to a block that does not exist in run-time mode an error message is shown.



Message object

Not valid for E50.

Message object presenting texts from message libraries.

Parameter	Description
Analog signal	Analog signal controlling which text from chosen message library to be shown. For valid devices see the driver manual.
Library	Select message library. Defined under Message Library in the Function menu.
Positions	Number of positions to be displayed. 0=automatic adjustment.
Security level	Select security level for the object. 0 means no security level. Not valid in E700 and E710.
Maneuverable range	A range of maximum 64 texts can be maneuverable in run-time mode. State the numbers of the first and the last texts of the range. See the section Maneuvering Textblocks.

Note!

When using indexed message libraries the number of positions should not be 0 since the automatic length adjustment doesn't work.

For more detailed information, see the chapter *Message library*.



Multiple choice object

Not valid for E50.

The object is linked to up to three digital signals which together can assume eight different states. A text of 30 characters can be linked to each state.

Multiple Choice

Analog signal:

Text:

0: Man.

1: Man.

2: Man.

3: Man.

4: Man.

5: Man.

6: Man.

7: Man.

Security Level:

Parameter	Description
Analog signal	This register decides which text to be presented. For valid devices see the driver manual.
Text 0 - Text 7	The texts that will be shown for each state of the object.
Man 0 - Man 7	States whether it is possible to maneuver this status in run-time mode. See the section Maneuvering Textblocks.



Text object

Not valid for E50.

Object for handling ASCII strings. It is possible to present the text stored in the registers of the controller system. Texts should be in ASCII format. The texts can be altered in run-time mode from the terminal by opening and closing the entry field with [ENTER] (not valid in E100).

The text is converted from 8-bit IBM extended ASCII to Swedish 7-bits ASCII if SW is stated on the command line in System Signals.

Parameter	Description
Analog signal	The register where text for the first position is stored.
Positions	Each register contains two characters (occupying two positions). The basic setting is 8 positions which is equivalent to four registers.
Maneuverable	Select if the object can be forcibly set in the run-time mode. Not valid in E100.

7.3 Maneuvering Textblocks

Text blocks consist of text lines with static and dynamic objects. The dynamic objects show the current status for those signals to which the object is linked. Certain dynamic objects are maneuverable which means that you can change their status and values in run-time mode.

To alter a maneuverable object you use the arrow keys to move the cursor to the right position so that the object is marked. Textblocks can be scrolled vertically but not horizontally

Digital objects

Digital objects are maneuvered by marking the required object. Then press [ENTER] to alter the status of the object.

Analog objects

Analog and Date/Time

The objects are maneuvered by placing the cursor on the right object. After this the new value is written in. Finish with [ENTER].

Before [ENTER] is pressed, new value entry can be aborted by leaving the field with [↑] or [↓]. The old value will then be retained.

Text objects

Maneuver a text object by moving to the object and pressing [ENTER]. Then an entry field is shown. The entry field is either on the first or last line depending where the object is on the display. Scrolling of the entry field takes place if the text is longer than the width of the display. Press [ENTER] when writing is complete. See "Numerical and alphanumeric keys in E100" on page 17 for description on how to enter different characters in E100.

Message objects

Maneuver a message object by moving to the object with the arrow keys and press [ENTER]. An option list is now shown with all maneuverable states on the display. Move to the required state, press [ENTER] and the analog signal linked to this state is forcibly set.

Multichoice objects

Maneuver a multichoice object by moving to the object with the arrow keys and press [ENTER]. An option list is now shown with all maneuverable states on the display. Move to the required state, press [ENTER] and the analog signal linked to this state is forcibly set.

Jump object

Move to the object and press [ENTER].

Bargraph object

The indicators for min and max value can be set to the actual value for the bargraph object by first select the object and then press [ENTER].

8 Trends

This chapter is not valid for E50, E100 and E200.

This section describes trends, real-time trends and historical trends.

8.1 Historical trends

Only valid for E600, E700 and E710.

This function means that analog values from the PLC system are collected and presented in a trend object while running. The presentation is in the form of a curve. The values collected are stored in the terminal's project memory.

It is possible to define several independent trend curves in the same or different blocks. The total number is limited by the project memory and the RAM of the terminal. The use of other objects and functions affect the total number of trends in a project, e.g. the number of alarms.

Such things as the time interval between collection of data and how many values are to be stored are defined in the trend object.

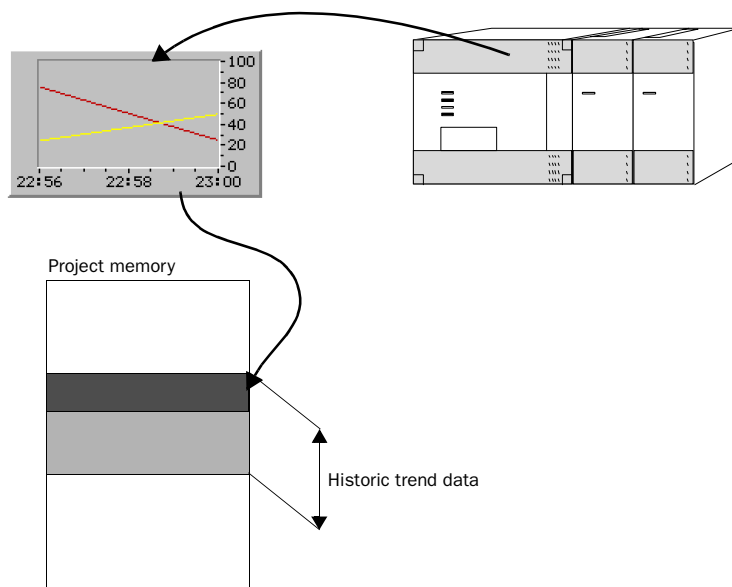

Calculate the trend size

If you want to know how much the trend data will occupy of the project memory the following calculation must be made.

$$S = TOS + AK (28 + (645 * ((AS / 100) + 1)))$$

S=The number of bytes.

TOS=TrendObjectSize, if all parameters for a trend object are changed the TOS will be 320 bytes.

AK=The number of defined curves in the trend object.

AS=The number of Samples is rounded up to the nearest hundred.

Note!

Even the RAM of the terminal can cause a limit of the number of trends in a project. The limit is dependent of other objects and functions used in the project.

Presentation in run-time mode

Trend curves can show historic data in the run-time mode. Mark the required trend object and press [ENTER]. A dialog square is now shown and the date for the data to be presented can be chosen. "History" is shown at the bottom of the square. Press [ENTER] again to return to real-time display. Trend data is stored in the files whose names are stated when the trend object is defined.

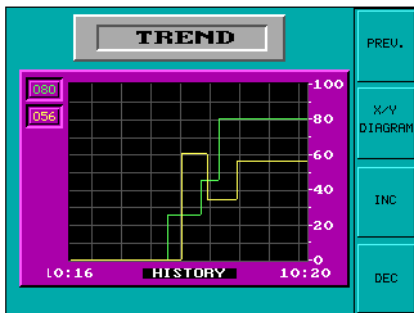

Trend History			
Left	time	:	10:32:00
Right	time	:	10:36:00
Left	date	:	97-05-21
Right	date	:	97-05-21
OK			

8.2 Real-time trends

Only valid for E300.

This function means that analog values from the PLC system are presented in a trend object while running. The presentation is in the form of a curve. No values are stored in the terminal's project memory and no historic data can be shown.

It is possible to define several independent trend curves in the same or different blocks. The total number of 10 trends can be used in an application.

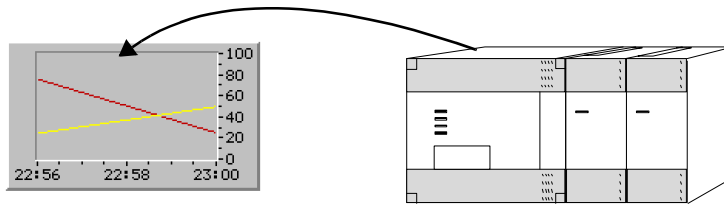

8.3 Defining trend objects

Trend objects are defined as other dynamic objects in a block. The object can be linked to up to six analog signals (two in E300 and E600). Unlike other objects, trend objects must be given a name with 1 to 8 characters. The first character must be a letter or a number. The standards for naming files in MS DOS are applied. The following parameters are defined for a trend object. Under Terminal options in the Setup menu you can decide if trends are going to be stored when changed or if all samples shall be stored. For more information see “The Setup Menu” on page 72

Parameter	Description
Name	State the name of the object. The name must be unique for each object.
Curve	Select the curve you want to edit 1-2 in E300, E600 and 1-6 in E700/E710.
Analog signal	The analog signals the object shall sample and present the values for. Only 16-bit numbers can be used. For valid devices see the driver manual.
Color	Select a color for each curve.
Offset and Gain	Used to scale register value. See the section General parameters.

Parameter	Description
Enable	The digital signal which when set starts the collection of data. Data collection ceases if the signal is set to zero. The parameter needs not be stated.
Y Min value reg.	The minimum value on the Y-axis loaded from the stated PLC register.
Y Minimum value	The minimum value on the Y-axis. (If Y Min value reg. is defined this is the minimum value that can be loaded from the register.)
Y Max value reg.	The maximum value on the Y-axis loaded from the stated PLC register.
Y Maximum value	The maximum value on the Y-axis. (If Y Max value reg. is defined this is the maximum value that can be loaded from the register.)
Y Scale	States which side of the Y-axis shall be shown, to the left, right, both or neither.
Y Scale division	The interval between the scale number on the Y-axis.
Y Scale ticks	The interval between the scale ticks displayed.
X Sample interval	States the time interval between the collection of data. Minimum value is 1 second and maximum value is 100 hours.
X Stored samples	States how many values shall be stored. The maximum number of values are 13000. Not valid in E300.
X Time range	States the time interval to be shown in the trend diagram.
X Time scale division	The interval between the scale number on the X-axis.
X Time scale ticks	The interval between the scale ticks displayed.
Sample full limit	State the number of samples when the samples full signal shall be set. Not valid in E300.
Sample full signal	Select a signal which will be set when the number of samples reach the value stated in the parameter Sample full limit. Not valid in E300.
Frame	Select if a frame shall be printed around the object.
BG	Select background color for the object.
Scale	Select the color of the scale in the object.
Erase trend data signal	The digital signal which when set will erase all historic trend data. Not valid in E300.
Grid	Select if grid shall be displayed in the object.
Grid color	Select a suitable color for the grid.

Note!

If you copy a block containing a trend object you must change the name of the trend object. Two trend objects may not have the same name.

8.4 Transferring historical trend data

Trend data and recipes can be transferred to and from a personal computer with the program *File Transfer* (a icon in the program group HMI Tools) for calculating statistics and other types of presentation and storage.

Trend files can for example be opened directly in Excel for statistical calculations. See the manual for HMI Tools.

Trend files

The name of the trend files is given for each trend when the trend objects are defined. The file will be allocated the extension .SKV. The format for each line in the trend file is as follows; DDDD;TTTT;AAAA;BBBB;CC-CC;DDDD;EEEE;FFFF:

Format	Description
DDDD	Date format given in Setup.
TTTT	Time format given in Setup.
AAAA	Trend curve 1.
BBBB	Trend curve 2 (if defined).
CCCC	Trend curve 3 (if defined).
DDDD	Trend curve 4 (if defined).
EEEE	Trend curve 5 (if defined).
FFFF	Trend curve 6 (if defined).

The oldest value is shown on the first line of the file and the latest on the last line. It is only when the value is changed a new row in the file is added. The .SKV format can be imported directly to Microsoft Excel. You can use the diagram manager to create statistical diagrams in Excel. It is not possible to alter something in the file and then send it back to the terminal. The picture below shows an example of how it can appear in Excel.

Edit Recipe: TREND1.skv

File Help

1996-01-04 Insert Row Delete Row Exit

Device	Value				
1996-01-04	21:08:16	1 6	61	46	31 16
1996-01-04	21:08:18	5 0	55	40	25 10
1996-01-04	21:08:20	7 2	57	42	27 12
1996-01-04	21:08:21	8 3	58	43	28 13
1996-01-04	21:08:22	9 4	59	44	29 14
1996-01-04	21:08:23	0 5	60	45	30 15
1996-01-04	21:08:24	1 6	61	46	31 16
1996-01-04	21:08:25	2 7	62	47	32 17
1996-01-04	21:08:26	3 8	63	48	33 18
1996-01-04	21:08:27	4 9	64	49	34 19
1996-01-04	21:08:28	5 0	65	50	35 20
1996-01-04	21:08:29	6 1	66	51	36 21
1996-01-04	21:08:30	7 2	67	52	37 22
1996-01-04	21:08:31	8 3	68	53	38 23
1996-01-04	21:08:32	9 4	69	54	39 24
1996-01-04	21:08:33	0 5	70	55	40 25
1996-01-04	21:08:34	9 6	71	56	41 26
1996-01-04	21:08:35	8 7	72	57	42 27
1996-01-04	21:08:36	7 8	73	58	43 28
1996-01-04	21:08:37	6 9	74	59	44 29
1996-01-04	21:08:38	5 0	75	60	45 30
1996-01-04	21:08:39	4 1	76	61	46 31
1996-01-04	21:08:40	3 2	77	62	47 32
1996-01-04	21:08:41	2 3	78	63	48 33
1996-01-04	21:08:42	1 4	79	64	49 34
1996-01-04	21:08:43	0 5	80	65	50 35
1996-01-04	21:08:44	9 6	81	66	51 36
1996-01-04	21:08:45	8 7	82	67	52 37
---	---	--	--	--	--

9 Message library

The chapter is not valid for E50.

With the function message library you create message tables where values between 0 and 65535 are linked to texts. The function is used for presentation of each step in a sequence control. Another use is presenting error codes. An analog signal generates the error codes which are linked to texts in a message library. The function can also be used to give analog signals specific values dependent of selected texts.

Message library is one or several message tables containing up to 512 text strings each. Each text string can have a length of 40 characters.

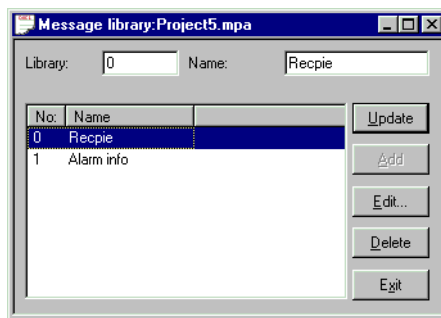

Parameter	Description
Library	State a number of the message library.
Description	State a name of the message library.

You edit a message library by marking a library and click on Edit. Several editing windows can be displayed at the same time.

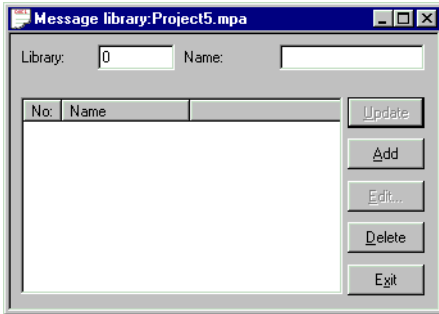

Parameter	Description
Text no	State a number of the text, 0-65535.
Text	Freely defined text which is displayed when current signal includes the text number for the text.

Example

The following example shows how the function may be used. In a sequence control we want to display a text for each step in the sequence.

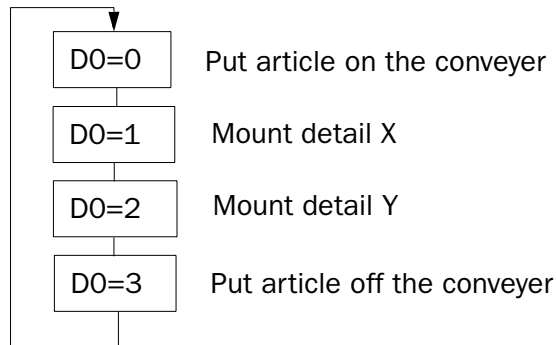

Start by creating a message library named Line1.

1. Select **Message library** in the **Functions** menu.
2. Define a number, in this case 0, and a name of the library, in this case Line1.
3. Click on Add.

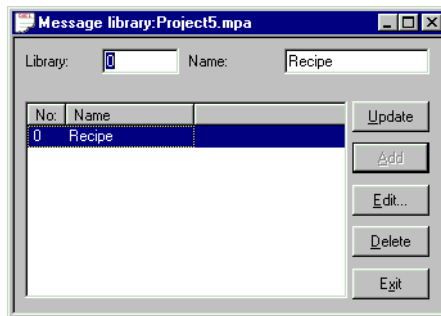

A message library named Line1 is now created. Thereafter you define the texts in the library.

4. Mark the library, line1, and click on Edit.

In this dialog you define text number and text. In the field **Text no** you state a value of the analog signal linked to the message object. In the field **Text** state the text displayed in the message object.

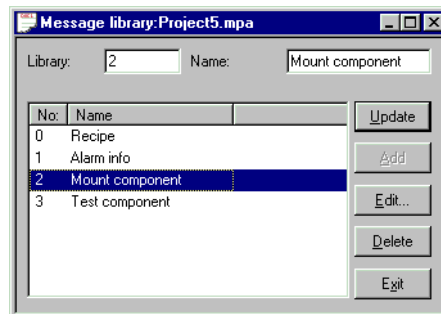

When the message library is defined, you create a message object in the project. Message objects can be defined in both text and graphic blocks.

5. Select the **Message object** in the toolbox. Place the cursor where you want to place the object and click.
6. State the analog signal to control which text is to be displayed.
7. In the field library you select message library.
8. Select if the object should be maneuverable and between which texts it may be changed.

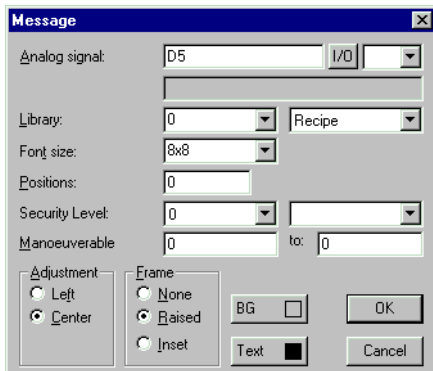

10 Alarm handling

The chapter is not valid for E50 and E100.

This section describes alarm management. The function is used to call the operator's attention on events in the process that need immediate caution. This function is divided into alarm groups, alarm messages and an alarm list. The alarms can be divided into groups, for example to create an order of priorities. The alarm messages are definitions of the signals that will activate an alarm as well as the alarm message for each signal. The alarm list contains alarms caused in the run-time mode.

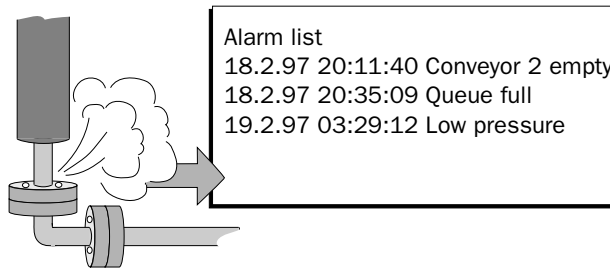

10.1 Alarm grouping

Alarms in the terminal can be divided into different groups depending on the terminal type. Each group can be allocated a certain color (E700 and E710). Alarms can be sorted into groups in the alarm block. It is not necessary to define the alarm groups.

Terminal	Number of alarm groups
E200	1
E300	4
E600	4
E700	16
E710	4-6 (depending on selected font size)

Defining alarm groups

Alarm groups are defined under **Alarm groups** in the **Functions** menu. The attribute for alarms in this group are decided in the following dialog box.

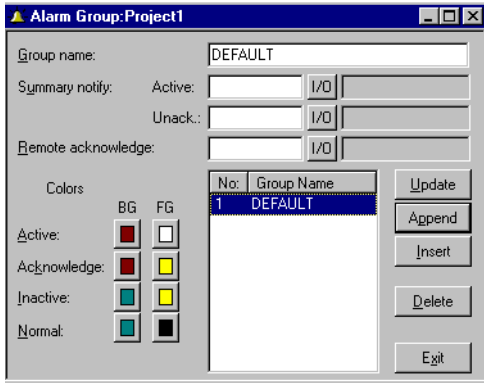

Parameter	Description
Group name	Any name for the alarm group.
Summary notify	Active - Digital signal which is set to unity when there is an active alarm in the group. Unack - Digital signal which is set to unity when there is an unacknowledged alarm in the group.
Remote acknowledge	Digital signal which acknowledges all the alarms in the group simultaneously.
Colors	States the colors for active, acknowledged, inactive alarms as well as the normal state for the alarm in the alarm list. Only valid in E700 and E710.

10.2 Alarm messages

Alarm messages are defined under **Alarms** in the **Functions** menu. The alarm message is entered here with a maximum of 38 characters, 18 characters in E200. More characters can be shown if a smaller font size is used in the alarm list. The message can contain dynamic data (just like a Text-block) which can be digital or analog. You can define 100-300 alarms depending on the application.

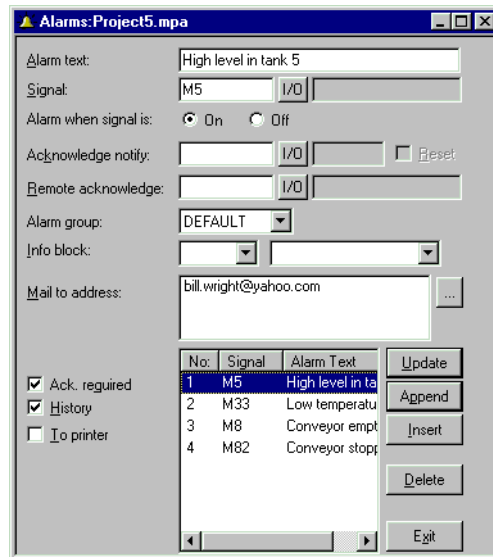

Parameter	Description
Alarm text	An alarm text containing static text, digital text and/or analog numeric.
Signal	The digital signal which when activated generates the alarm is stated here.
Alarm when signal is	Select On if a set signal should cause an alarm. Select Off if a reset signal should cause an alarm.
Acknowledge notify	Digital signal affected when the alarm is acknowledged. Normally the signal is set.
Reset	The above signal is set to zero when the alarm is acknowledged if Reset is marked.
Remote acknowledge	Digital signal which acknowledges the alarm when activated.
Alarm group	States the alarm group for the definition.

Parameter	Description
Info block	State a block number of a text or graphic block. This makes it possible to give the operator a “help page” containing information about the alarm and possible actions. 0 means that no block are linked to the alarm. If the information block is a textblock it will be included if the alarm is sent as an email message. See the chapter Alarms in <i>run-time mode</i> .
Mail to address	When an alarm is activated an email can be sent to a predefined receiver. The alarmtext is then the subject. See the section “SMTP Client”.
Ack. required	States if the alarm should be acknowledged or not. A cross in the square means that the alarm must be acknowledged and no cross means that the alarm functions as an indicator alarm, that is as a form of information.
History	States when the alarm shall be taken out of the alarm list. A cross means that the alarm remains in the list until the alarm list is full. No cross means that the alarm is taken out of the list when it is acknowledged and is no longer active. If the Acknowledge parameter is not marked then the alarm is taken out of the list as soon as it is not active.
To printer	Whether the alarm message should be printed out directly if the alarm status changes is stated here.

10.3 Configuring the alarm list

General settings for the alarm list are made in **Alarm settings** in the **Setup** menu. Alarms take different amounts of space in the alarm list depending on the length of the alarm text and the number of objects in the alarm message.

$$S = 19 * AO + NC$$

S = The number of bytes.

AO = The number of objects in the alarm message.

NC = The number of characters in the alarm message.

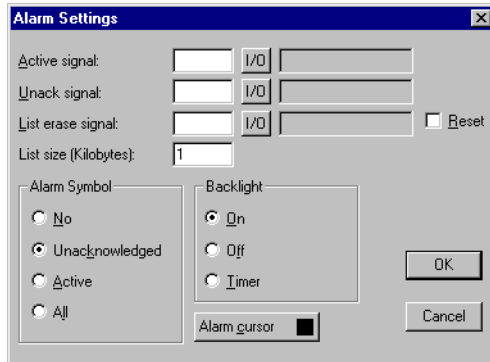

Parameter	Description
Active signal	States the digital signal which the terminal set when there is an active alarm.
Unack signal	States the digital signal which the terminal set when there is an unacknowledged alarm.
List erase signal	States the digital signal which when set erases all not active alarms in the alarm list.
Reset	Means that the signal stated on List erase is set to zero when the alarm list is erased.
List size	States the list size in number of kbytes for E300, E600, E700 and E710 and in number of alarms in E200. Note that the real size of the alarm list is twice the stated size. The performance of the project is effected negatively if list sizes over 10 kbytes is used (100 alarms in E200).
Alarm symbol	States when the alarm symbol should be shown, see table below. ■ALARM■ is shown in the Textblock and a red bell,  , in the top right-hand corner of the display is shown in the Graphicblock.
Backlight action	State when the background light shall be turned on at alarm. On means that the backlight is turned on when the alarm symbol is shown. Default setting. Off means that the backlight is not affected by alarms. Timer means that the backlight is on when a new alarm is activated and turns of when the time for the screen save is out.
Alarm cursor	In E700 and E710 the cursor color can be changed in the alarm list.

Option	Alarm symbol shows when	
	active	unacknowledged
NO		
UNACK		•
ACTIVE	•	
ALL	•	•

10.4 Alarms in run-time mode

Alarms are shown in the Textblock with the text ■ALARM■ in the upper right-hand corner of the display (you can select not to have this during configuration). A red bell blinks in the upper right-hand corner of the display for alarms in Graphic blocks.

The alarm is presented in an alarm list with the predefined alarm texts. The alarm list contains the latest alarms which are listed according to alarm group according to definition and with the latest alarm at the top of the list. The alarm list's size in number of kbytes is selected during configuration (number of alarms in E200). The alarm list is shown on jumping to the alarm block. The status for the alarm is shown for each alarm as well as the time when the alarm was activated, deactivated or acknowledged depending on the selected display mode.

Alarms can have the following status.

Symbol	Status
*	Active, Not acknowledged
\$	Not active, Not acknowledged
-	Active, Acknowledged
<blank>	Not active, Acknowledged

Alarms can be shown in the following format.

Display format	Description
S	The time when the alarm was activated
E	The time when the alarm was inactivated
A	The time when the alarm was acknowledged

To get to the alarm block you can either press [LIST] or define a jump to system block 990 or allow the controller system to produce a list via the Display signal for block 990.

To acknowledge an alarm place the cursor on the line where the alarm is and press [ACK]. Alarms can be printed out directly as they occur or change status if a printer is connected. This should be stated when the alarm is defined. The alarm is printed out with date, time, status and the alarm text.

Return to the previous block by pressing [LIST] on the terminal.

The current content of the alarm list can be printed out by giving the Printer signal for block 990.

Block linked to alarms

Text or graphic blocks can be linked to alarms. This means that when the operator press the INFO key at an alarm in the alarm list a block linked to the alarm is shown. This block can contain information about the alarm and recommended actions. It is only possible to press the INFO key if current alarm is linked to a block. Return to the alarm list by pressing [PREV] on the terminal.

10.5 Graphic alarm page in run-time mode

The page is graphic and can be modified by the user. The function keys can be linked to the functions in order to enlarge or reduce the text on the alarm page as well as the function for flipping through the pages. Furthermore there is the possibility to select the showing of date and time.

Alarms can be sorted into groups and you can select which group is to be shown. Status is shown with different colors, the color defined when setting the alarm group. In E300, E600 and E700 you select alarm group with the arrow keys left and right.

E700

Alarm symbol Alarm message Current alarm line

```

$ Meltdown
$ High temperature
$ PLC batteri low
$ PLC batteri low
$ High temperature
$ High temperature
$ Meltdown
$ Meltdown
$ Meltdown
    
```

Alarm info

Increase the font size

Decrease the font size

Switch on/off the date and time stamp

ALL red green yellow

Alarm groups

E710

Alarm symbol Alarm message Current alarm line

```

$ MOTOR4 READY
* MOTOR2 RUNNING FAST!
- PLC BATTERI LOW
* DOOR1 OPEN
- TANK3 LOW PRESSURE!
MOTOR2 RUNNING FAST!
* TANK1 HIGH TEMPERATURE!
$ TANK1 HIGH TEMPERATURE!
    
```

Leave the alarm list

Page up

Acknowledge

Increase the font size

Alarm info

Switch on/off the date and time stamp

Page down

ALL WARNING MESSAGE

Alarm groups

11 Recipes

The chapter is not valid for E50.

This chapter describes the function recipe handling. The recipes function means that all dynamic data in a block, that is signals and their values, can be saved to in the run-time mode. The operator can then down-load the file to the PLC system. The PLC system then starts to work with the loaded values. By using the recipe handling function a large amount of parameter settings can easily be reused. The user creates a recipe library containing files with different parameter settings. This function makes time-critical production more efficient. For example when you often shift between similar products e.g. when producing a unit in different colors. The recipe files can be created from the terminal, from the PLC system or from a PC with the software HMI Tools.

Recipe files are stored in the terminal. To use recipes, the functions for storing, loading and erasing recipes must be linked to function keys, see the chapter *Function keys*.

The diagram below shows the principle for managing recipes.

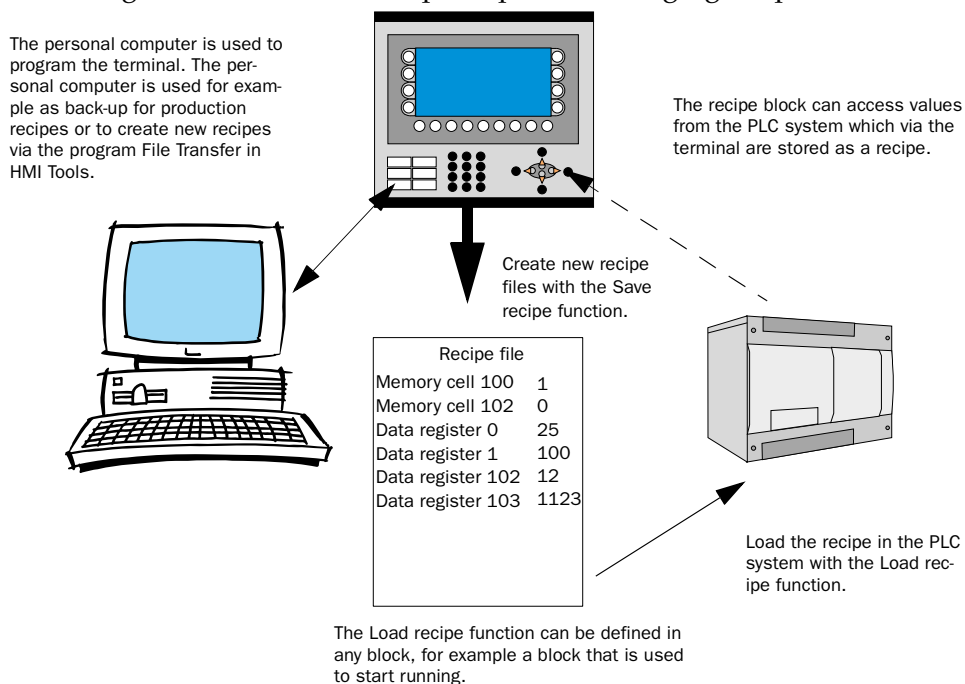

11.1 Calculate the recipe size

Use the following equation to calculate how much the recipe will occupy the project memory.

$$S = 90 + \Sigma (2 * IOG_i + 28)$$

S = number of bytes. If S calculated will be less than 360, S will be set to 360.

Σ = the number of IO-series

IOG_i = the number of IO in each IO-series

Example

Our recipe has the following series data register 0-109, 200-499 and memory cell 0-99. Our recipe consists of 3 I/O series.

The calculation will be:

Calculate the sums of the different series:

$$1104 = (2 * 110 + 28) + (2 * 300 + 28) + (2 * 100 + 28)$$

Then calculate the sum:

$$S = 90 + 1104$$

$$S = 1194 \text{ bytes}$$

11.2 Creating a recipe with the terminal

Which block or blocks are to be used to save the recipes is decided when the application is programmed. All those signals that are to be included in the recipe are defined in the block that will be saved as a recipe. All dynamic values in the block are stored in the recipe file. All digital and all analog objects except trend objects can be used as recipe parameters.

A jump is made in run-time mode to the block which contains the recipe parameters. Enter the required values in the dynamic object and press the function key which is linked to Save recipe. The name of the file is given in the entry field shown. The recipe file is stored in the terminal.

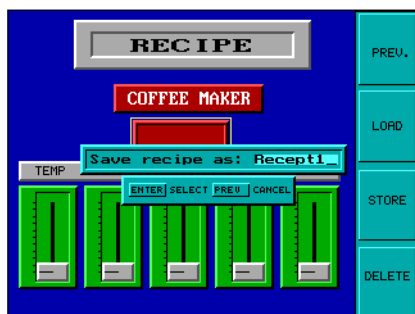

11.3 Transferring a recipe to the PLC system

The recipe is transferred to the PLC system in run-time mode with the Load recipe function. This means that the signals and their values stored in the file are transferred to the PLC system. When the function key for Load recipe is pressed a list of available recipe files to choose from is shown. Select one and press [ENTER]. The PLC system will then run with the down-loaded values.



11.4 Erasing a recipe

Any named recipe can be erased in run-time mode from the terminal memory with the Delete recipe function. Press the function key connected to Delete recipe. Available recipe files to choose from are now shown. Select the file to be erased and press [ENTER]. Confirm the erasure by pressing [ENTER] or abort by pressing [PREV].

11.5 Using recipes in a personal computer

With the program File Transfer, in the program group HMI Tools, recipes can be transferred between the terminal and a personal computer. This means that the personal computer can be used for making safety copies of files in the terminal. New recipes can be created in the personal computer and be transferred to the terminal.

The files are stored in the .SKV format in the personal computer which can be brought up in Excel. Files can be edited in Excel and then used in the plant again.

Note!

The file must end with the instruction END.

For further information we refer to the manual for HMI Tools.

11.6 Loading and saving recipes via the PLC program

By using a control block in the PLC system you can load, save and delete recipe files in the terminal. The files created by the PLC program are compatible with the recipe files saved in the terminal. This means that recipe files saved by the PLC program can be loaded in the terminal and vice versa.

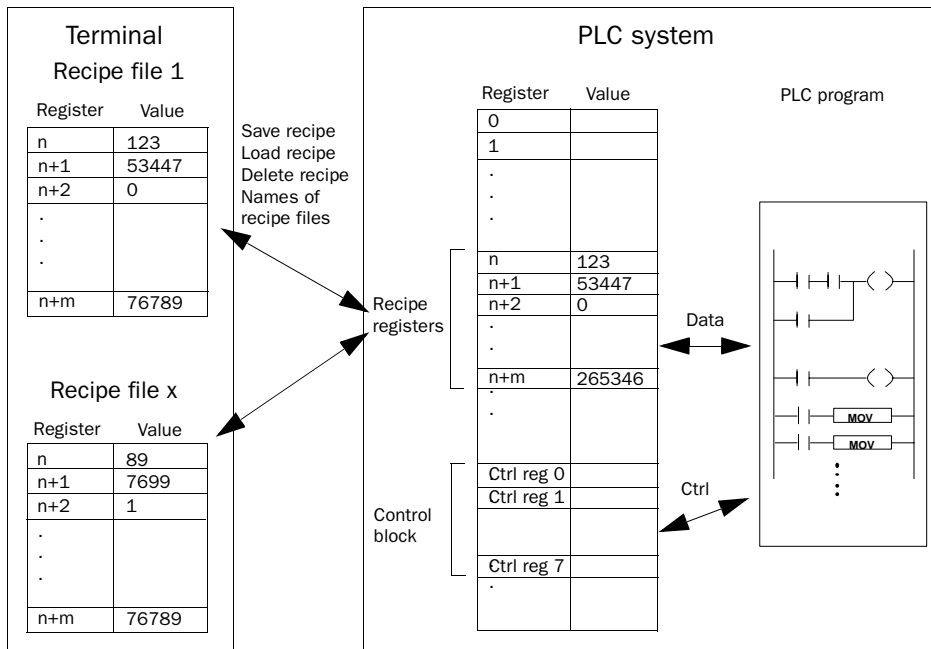

In the **Setup** menu, **System signals** you define the first register in the control block. This register and the seven following registers are used as control registers. The control block is described in the following table.

Register	Content	Description
Ctrl reg 0	Command	Command register set by the PLC Available commands: 0: No command 1: Save recipe to the terminal. 2: Read recipe from the terminal. 3: Delete recipe from the terminal.
Ctrl reg 1	Result code	Handshake register set by the terminal. 0: Ready for new command. 1: OK. 2: Recipe file write error. 3: Recipe file not found.
Ctrl reg 2	File name char. 1-2	Recipe file name in the terminal.
Ctrl reg 3	File name char. 3-4	
Ctrl reg 4	File name char. 5-6	
Ctrl reg 5	File name char. 7-8	
Ctrl reg 6	Start data register	The number of the first data register to be read/ written to/from recipe file. (n in the figure below)
Ctrl reg 7	Number of registers	Number of registers to read/write to/from recipe file. (m in the figure below).

To perform commands, the following handshake procedure must be carried out:

1. The handshake register must be 0. If it is not, make sure that the command register is set to 0.
2. Write the command in the command register.
3. Wait for completion or error code in the handshake register.
4. Set the command register to 0. After this, the terminal will set the handshake register to 0.

Example

The PLC wants to save D100 to D149 as recipe name “RECIPE1” when M0 is activated. The control block starts at D10. The PLC program should be as follows.

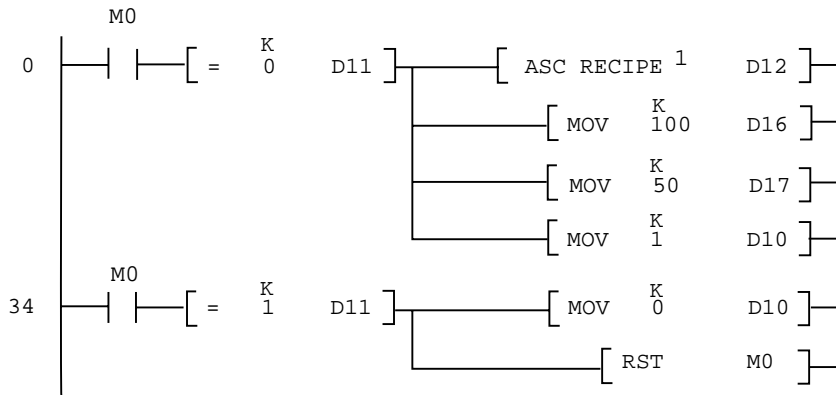

Limitations

Recipe created in the PLC system can include maximum 1000 registers. Only data registers can be used.

The following characters can not be used in recipe names:

! ? < > () + / * = ° % # : . [space] , -

12 Passwords

The chapter is not valid for E50.

This section describes how to use security levels and passwords in the terminal. This function makes it possible to create a security system for the terminal. The operators can be given different accessibility to the system.

Blocks, function keys and maneuverable objects can be allocated a security level. Each security level is given a password. The user must log in with a password for the security level concerned or a higher one to gain access to the various levels. It is not essential to use this function.

12.1 Defining security levels

Blocks, function keys and maneuverable objects can, when they are defined, be allocated a security level. A security level (0 to 8) is given in the dialog box for the object. Everyone will have access if the 0 security level is used.

12.2 Defining passwords

The passwords are defined for security levels 1 to 8 under **Passwords** in the **View** menu.

Security level:	Password	Confirm question	Comment
1:			
2:			
3:			
4:			
5:			
6:			
7:			
8:			

Login signal:	<input type="text"/>	I/O	<input type="text"/>
Logout signal:	<input type="text"/>	I/O	<input type="text"/>
Current level reg:	<input type="text"/>	I/O	<input type="text"/>
Login timeout:	<input type="text" value="0"/>	minutes	
Password run/prog:	<input type="text"/>		

Parameter	Beskrivning
Password sec level 1-8	Enter the password and any comments for security levels 1-8.
Confirm question	Enter a question that should be confirmed by the operator before maneuvering is enabled.
Login signal	State here the digital signal which when set generates the entry field for logging in. The entry field for logging in can also be linked to a function key, see the Function keys section.
Logout signal	State here a signal which when set logs out the current user. This function can also be linked to a function key, see the Function keys section.
Current level reg	State a register where the terminal put the current password level (0-8).
Login timeout	State here the time in minutes during which the terminal can remain unused before the user is automatically logged out. If 0 is used no logging out takes place.
Password run→ prog	Here you can state a password which must be entered when switching from RUN to PROG manually. The function is not used when switching from PROG to RUN or when Auto RUN/TRANSFER switching from the MAC Programmer+ is used.

12.3 Logging in

Logging in is either controlled from a function key or through a digital signal from the PLC system. The entry field for logging in is shown if the function key linked to the function Login to specified security level is pressed or the digital signal is activated. State the password here. The password is linked to the security level, see above. If the security level is changed to a higher level the [PREV] key will be disabled.

12.4 Password for transfer

On the command line under System signals in the Setup menu you can state the command PDxxxxxxx where xxxxxxxx is the password. The operator then have to enter the password to access the functions in the Transfer menu.

12.5 Password for all terminal functions

On the command line under System signals in the Setup menu you can state the command PSxxxxxxx where xxxxxxxx is the password. When the operator enter the password he has access to all functions in the terminal, even the functions protected with other passwords.

12.6 Altering passwords in run-time mode

Passwords can be altered in run-time mode with the Change login password function. When the function key linked to Change login password is pressed a dialog is shown where the password for each security level can be altered.

Note!

It is not possible to state the security level for block 0.

Note!

After logging out the [PREV] key and the function "Return to previous block" for the function keys is ignored to provide unauthorized to enter block that have password.

13 Report print-outs

The chapter is not valid for E50.

This section describes how to make a report print-out from the terminal. For production follow-up it is simple to create different types of reports such as daily reports and event reports. The illustration below shows the principle for generating a daily report.

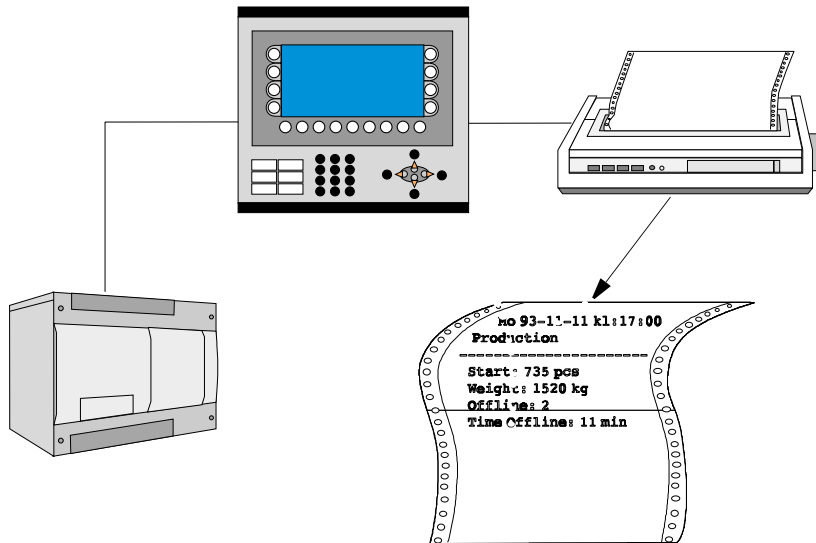

13.1 Connection to a printer

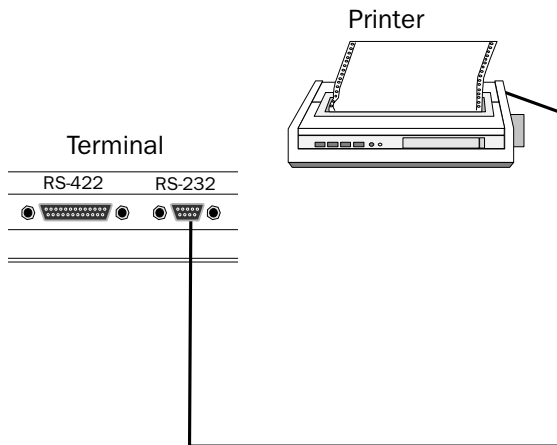

The printer should have a serial interface and be equipped with IBM character set (850). The settings for the printer are set under **Peripherals** in the **Setup** menu in the terminal. Refer to the printer manual for the correct configuration.

Note!

A printer with parallel interface can be connected if the expansioncard IFC PI is used.

13.2 Text block printouts

The reports are created as Text blocks with static and dynamic text. The report has a maximum width of 150 characters. In the text block you enter a free text, e.g. table head and other static text which always will be printed. To get dynamic values from the process in the report you define dynamic objects, presenting the value for the signal the object is linked to. See the chapter *Textbased presentation and maneuvering*. Via time channels it is possible to decide when the report is to be printed.

13.3 Graphic block printout

In E300, E600, E700 and E710 it is possible to print a graphic page to a Epson FX-80 or HP PCL5 compatible printer. Graphic blocks can only be printed when it's displayed (screen dump). Only black and white graphics are supported.

13.4 Defining the print-out

The **Print signal** parameter in the block header gives the signal which when set activates the print-out. A **Completion signal** is also given here which is set by the terminal when the print-out is completed. This signal is instead set to zero if **Reset** is marked.

13.5 Printer settings

The settings for the printer must be made under **Peripherals** in the **Setup** menu. Under Peripherals you select **Printer** and then press **Edit...** For more detailed information concerning the printer refer to the manual for the printer used. If you select Standard text the printer must support IBM extended ASCII character set. If graphic blocks are printed the printer must support Epson FX-80 or HP PCL graphics. If you use the expansion card IFC PI it is possible to print on a HP writer.

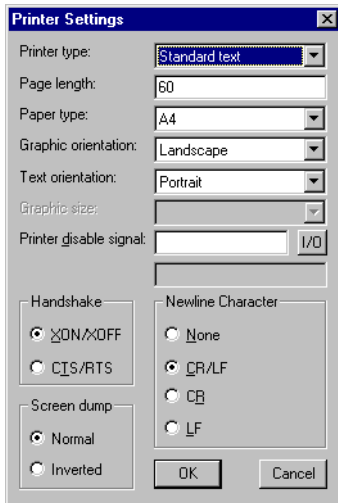

Parameter	Description
Printer type	Select printer, none or installed printer, e.g. HP PCL5.
Page length	The number of lines to be printed out before form feed. Form feed never takes place if the page length is set to 0.
Paper type	Select paper type according to installed printer.
Graphic orientation	States if the graphic printout should be portrait or landscape if a PCL5 compatible printer is used.
Text orientation	States if the report printout should be portrait or landscape if a PCL5 compatible printer is used.
Printer disable signal	State a digital signal which when set closes the printout. The port where the printer is connected will then be free to use for e.g. transparent mode. Not valid if IFC PI is used.

Parameter	Description
New line character	End of line character; CR/LF, CR, LF or none.
Handshake	States whether handshaking between the printer and terminal will take place with XON/XOFF or CTS/RTS.
Screen dump	Possibility to printout the screen, normal or inverted.

13.6 Setting a communication port

Settings for the communication port must be made under **Peripherals**. Under Peripherals you select **RS-232** or **RS-422** and then press the **Edit...** button. See the manual for the printer concerned for the correct setting.



Parameter	Description
Baudrate	Select the transfer rate for communication. Must be the same as the external unit.
Parity	Select parity. Must be the same as the external unit.
Databits	Select number of data bits. Must be the same as the external unit.
Stopbits	Select number of stop bits. Must be the same as the external unit.

13.7 Control codes to printer

Not valid for E50, E100 and E200.

It is possible to type control codes to a printer in textblocks. You type %% followed by a number between 1 and 31, which are control codes to printer. For example %%12 which is paper feed, for further description of control codes we refer to the manual for the printer used.

One command must be followed by a blank character. If you have set a transverse (paper) feed must this be at the end of the line. The characters %% must not occur in the text. It is possible to have more than one command/control code on one line.

14 Time control

The chapter is not valid for E50.

Time control is a function for setting and resetting digital signals relative to the real-time clock. This function is used for controlling events in the process at specific times through the terminal. The time channels replace the time relays and 7-day clock.

14.1 Defining the time channels

The time channels are defined under **Time channels** in the **Functions** menu.

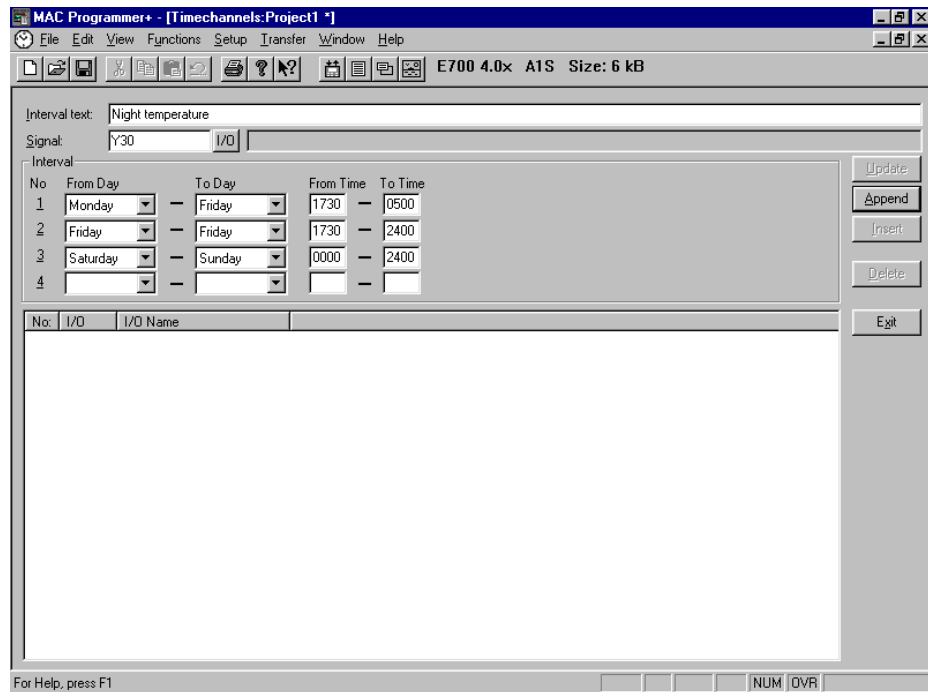

Parameter	Description
Interval name	Enter any text for the time channel.
Signal	A digital signal which is set during the stated time period is stated here.
Interval	The day and time for the interval is stated here. Four intervals can be defined for each time channel.

In the figure above we have defined one time channels. The time channel has the text Night temperature and is linked to the signal Y30. The signal will be set Monday to Thursday 17.30 to 05.00, Friday 17.30 to 24.00 and Saturday to Sunday between 00.00 and 24.00. During these periods the temperature in the building will be decreased.

14.2 Presentation in run-time mode

The page with the time channels is shown when system block 991 is activated either through a jump object or a digital signal linked to the block. The time channel's values can be read and/or changed. The option Time channels in the Online settings menu must be set to YES in order to alter the time channel's value in run-time mode.

To read or change values for a time channel you move the cursor to required line and press [ENTER]. Press [DONE] to exit from the time channel's definition. Exit from the time channel menu with [PREV]. The block from which the time channel block was activated is then shown.

15 System monitor

The chapter is only valid for E700 and E710.

The system monitor is a block where the operator can view or change the value for controller signals in run-time. The value is presented as an decimal, hexadecimal och ASCII value.

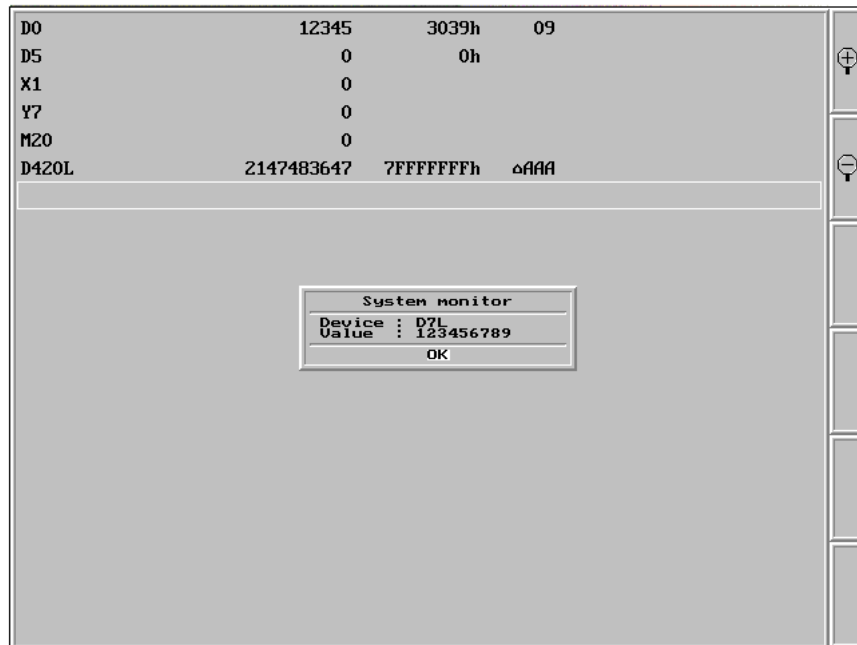

16 Index addressing

The chapter is not valid for E50.

Without index addressing, an object will always be tied to the same register. Only the value in that register can be displayed in the object.

With index addressing, however, it is possible during operation to select the register which is to be addressed, and thereby the value to be displayed. This is done by adding the value in the index register to the address of that register which represents the analog signal in the object. This can generally be formulated as follows:

Displayed value = contents of Register(object address + contents of Index Register)

If the contents of the Index Register is 2 and the address of the register specified in the object is 100, the value shown in the object will be retrieved from register 102. If the value in the Index Register changes to 3, the object's value will be retrieved from register 103 instead.

For each project you define which registers to be index registers. Make this under **Index Registers** in the menu **Setup**. Up to eight different index registers can be used in each project and each index register can be used in more than one object.

The object used in the project will specify if index addressing is to be used, and the relevant index register. This is done when the object dialog selects I1 to I8 in the entry field to the right of the specified analog signal for the object. In the example below, D100 is the analog signal, and I1 is the relevant index register.



The following example shows three motors which are controlled by a block. The correct torque and speed for the motors are stored in six different registers. In one block, it will be possible to select one of the motors and the correct torque and speed for that particular motor should thus be shown in the block. If another motor is chosen, its correct torque and speed should be selected and displayed. This functionality is possible with index addressing.

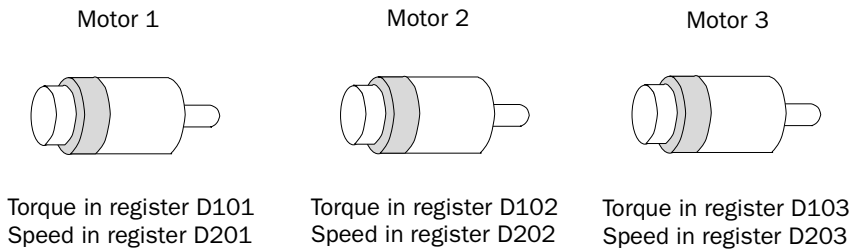

Register D0 is defined as Index register 1 at **Index Registers** in the **Setup** menu. The value in this register determines the motor for which torque and speed are displayed.

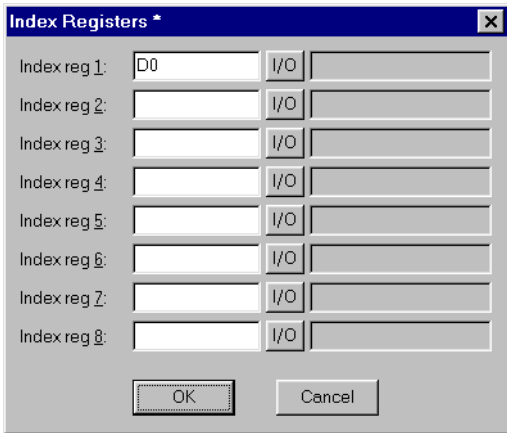

If the value in D0 is 1, torque and speed are shown for Motor 1. If the value is 2, torque and speed are shown for Motor 2, and so on. The value in register D0 is controlled by a multiplechoice object where the texts, Motor 1, Motor 2 and Motor 3 are specified. These three choices are also made maneuverable.

Multiple Choice *

Analog signal: D0 I/O

Text:

0: Man.

1: Motor 1 Man.

2: Motor 2 Man.

3: Motor 3 Man.

4: Man.

5: Man.

6: Man.

7: Man.

Adjustment

Left

Center

Frame

None

Raised

Inset

BG

Text

Font size: 8x8

Security Level: 0

OK Cancel

Torque and speed are shown in two numerical objects. In the object for torque, D100 is specified as the analog signal, and I1 as the index register.

Analog Numeric *

Analog signal: D100 I/O I1 Signed 16-bit

Positions: 5 Maneuverable

Adjustment

In the object for speed, D200 is specified as the analog signal, and I1 as the index register.

With the maneuverable multiple choice object, it becomes possible during operation to choose Motor 1, 2 or 3. Depending on the choice taken, a value of 1, 2 or 3 is marked in register D0. This value is added to the addresses for the objects that show torque and speed. These will thus display the values in registers D101, D102 or D103, and D201, D202 or D203 respectively.

Multiple choice object

Analog signal D0



Numeric object

Analog signal D100
Index register D0

Numeric object

Analog signal D200
Index register D0

Note!

Suffixes other than index register can be specified. The index register will not be counted twice if 32-bit register are used.

17 Communication

The chapter is not valid for E50.

17.1 Transparent mode

The programming/printer port on the terminal is used in the transparent mode to connect a unit working in parallel with the PLC system. This unit can be another terminal or a personal computer with for example the programming tool for the controller system or a superior operating system.

The transparent mode works together with the MELSEC CPU port and MELSEC A-series communication ports with C24 protocol. For further information see the respective C24 manual.

Connecting a personal computer or other computer system

Personal computers with the MELSEC MEDOC programming tool or other computer system are connected directly to the terminal's programming/printer port.

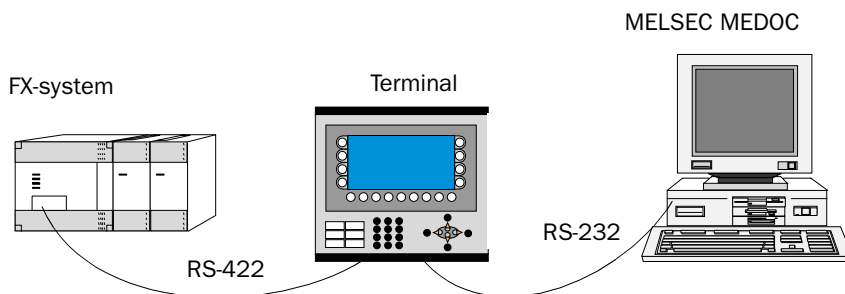

Terminal with MELSEC MEDOC connected to the programming/printer port

Settings in the terminal and MELSEC MEDOC

The following settings must be made in the terminal and MELSEC MEDOC for the transparent mode to work.

The terminal

The printer parameters are set in the **Setup** menu under the menu option **Peripherals**.

The parameters should be 9600 baud, 7 data bits, 1 stop bit and even parity if the terminal is connected to an FX system.

The parameters should be 9600 baud, 8 data bits, 1 stop bit and odd parity if the terminal is connected to a A-CPU or a QnA-CPU.

The parameters should be 19,200 baud, 8 data bits, 1 stop bit and no parity if the terminal is connected to one of the A-series or QnA-series serial communication modules.

MELSEC MEDOC

The transfer parameters should be changed to 19,200 baud, 8 data bits, 1 stop bit and no parity when transferring via the A-series communication ports. This is done under **Transfer** in **Setup**. The Interface should also be changed from CPU to C24 under Transfer.

The transfer parameters should not be changed in MELSEC MEDOC for other projects. See the Installation manual for cable connections.

The settings also apply for other PC-based monitoring systems such as SCADA and MELSEC MEDOC *plus*.

Connecting two terminals in transparent mode

Several terminals can be connected to the same PLC system with the function transparent mode. In this section we describe how to connect two terminals. Several terminals are connected in a analog way.

Cable connection

When connecting two terminals to a PLC system the first terminal is connected according to the description in the Installation manual. Between the two terminals a cable according to the figures below is used. The cable is connected between the free port on the first terminal and the corresponding port on the second terminal. If the distance is more than 15 meters using RS-232 communication a signal amplifier must be used.

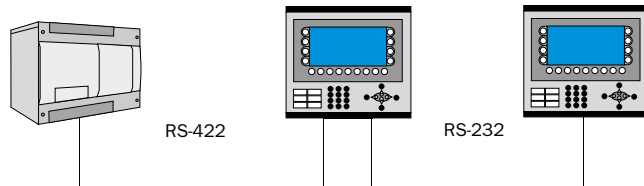

9-pos D-sub Female

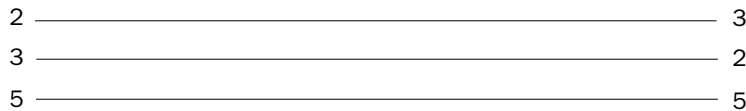

9-pos D-sub Female

Cable between two terminals using RS-232

25-pos D-sub Male

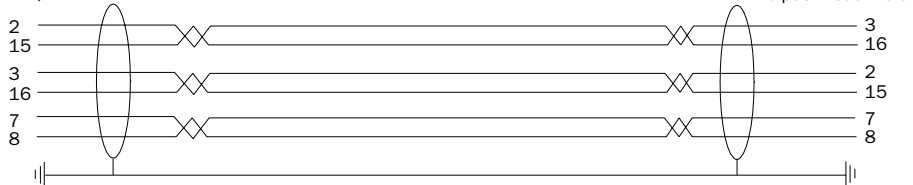

Cable between two terminals using RS-422

Settings in the first terminal

In MAC Programmer+ the communication settings is made in the **Setup** menu under **Peripherals**. Settings for the port connected to the PLC system is stated in the common way. Settings for the port connected to the other terminal can be freely chosen.

Settings in the second terminal

In MAC Programmer+ the communication settings is made in the **Setup** menu under **Peripherals**. The PLC system should be placed on the port that is used to connect the second terminal to the first terminal. The settings for this port shall be the same as stated in the first terminal on the port where the second terminal is connected. If any of the PLC systems FX2N or QnA is used the command BSD must be stated on the command line under **System Signals** in the **Setup** menu.

Transfer speed

The transfer speed can vary between 600 and 19,200 baud. The highest transfer speed between the terminals is recommended to obtain the best results. The speed of communication decreases with the number of terminals connected according to the following table.

Number of terminals	Access time to the PLC			
	Terminal 1	Terminal 2	Terminal 3	Terminal 4
1	100%	-	-	-
2	50%	50%	-	-
3	50%	25%	25%	-
4	50%	25%	12,5%	12,5%

Connecting three terminals in transparent mode

A third terminal can be connected to Terminal 2 in the network using a cable according to the figures above. The settings in the third terminal should be analog to the settings in the second terminal.

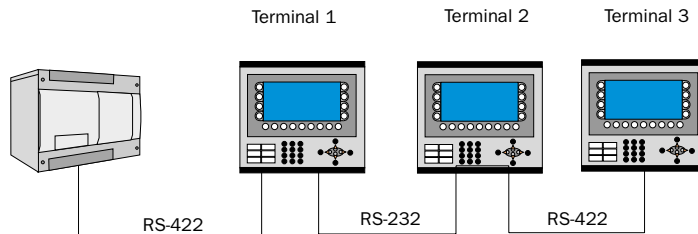

17.2 The terminal as communication interface (No protocol mode)

The *No protocol mode* is used to connect different PLC systems or connect external units such as bar code readers or weighing scales to the PLC system. The PLC system controls what is to be sent to the communication port. Data coming in to the communication port is written to the PLC register. Communication takes place with the transfer of the PLC register area according to the control block below.

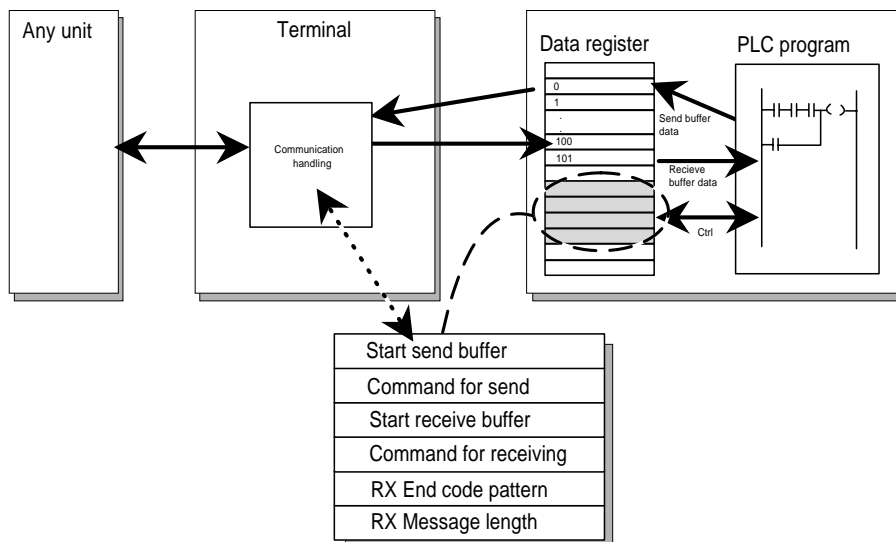

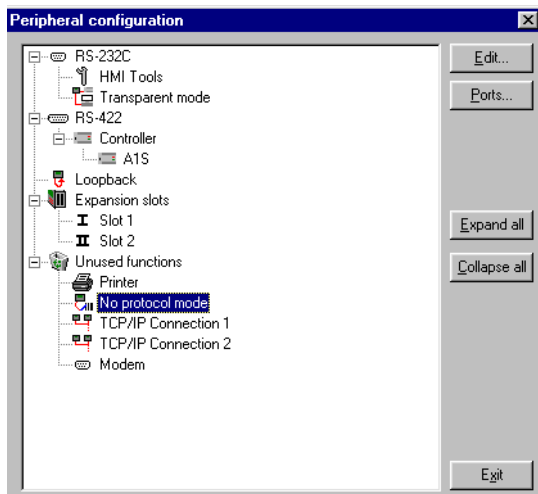

Rightclick on No Protocol Mode in Peripheral Configuration under **Peripherals** in the **Setup** menu.

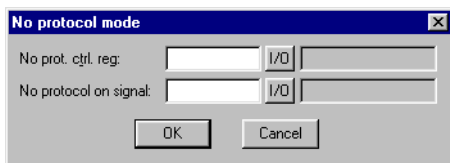

Register	Beskrivning
Ctrl reg 0	<i>Start register for the transmission data buffer.</i> The first register in the buffer area contains the total number of bytes to be transmitted. The following registers contains the data to be transmitted. The maximum buffer size is 127 registers = 254 bytes.
Ctrl reg 1	<i>Command register for transmission.</i> Set to 1 by the PLC system when transmission is required. Set to 0 by the terminal when transmission is complete.
Ctrl reg 2	<i>Start register for the reception data buffer.</i> The first register in the buffer area contains the total number of bytes received. The following register contains the data received. The maximum buffer size is 127 registers = 254bytes.

Register	Beskrivning
Ctrl reg 3	<p><i>Command register for reception.</i></p> <ul style="list-style-type: none"> - Set to 0 by the PLC system when it is ready to receive. - Set to 1 by the terminal when the message is available. - Set to -1 (FFFF) on error message (e.g. too short). - Set to 2 by the PLC system when clearing of the port buffer is required. - Set to 3 by the terminal when clearing of the port buffer has been carried out. <p>The port buffer is automatically cleared on start up and when switching between transparent mode and no protocol mode, i.e. the register receives the value 3.</p>
Ctrl reg 4	<i>End code (1 or 2 bytes) on the message received.</i>
Ctrl reg 5	<i>Length of the message received. End code is used if 0.</i>

In the **Setup** menu, **Peripherals** you drag the icon No Protocol mode to the communication port you will use. Right click to define which register will be the first control register in the transfer area. This and the five following registers are used as control registers.

The PLC system can switch between no protocol and transparent/printer modes in the run-time mode using a digital signal. State the digital signal in the dialog under No protocol on signal.

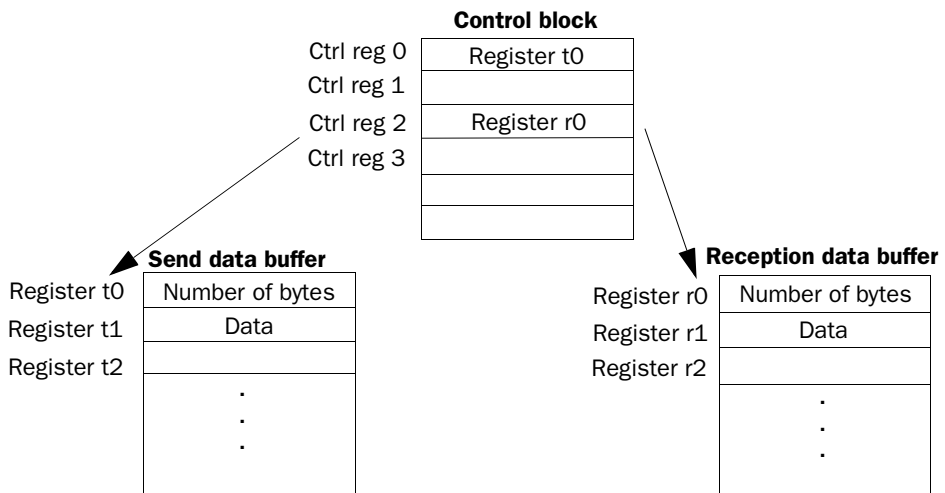

Example of using the No Protocol mode

The following example describes the use of the No Protocol mode for a weighing system. The diagram below shows a three-step block schedule for communication.

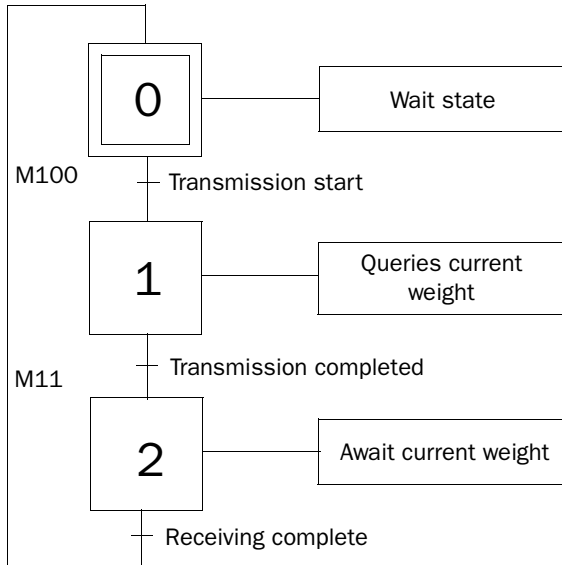

The terminal functions as the master towards the weighing system, that is it continually asks the weighing system for the current weight. The diagram below shows the connections between the PLC system, terminal and weighing system.

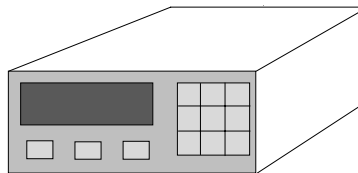

The protocol appears as follows

Terminal

| STX | ? | CR | LF |

Weighing system

| STX | Weight in kg | CR | LF |

The PLC program appears as follows:

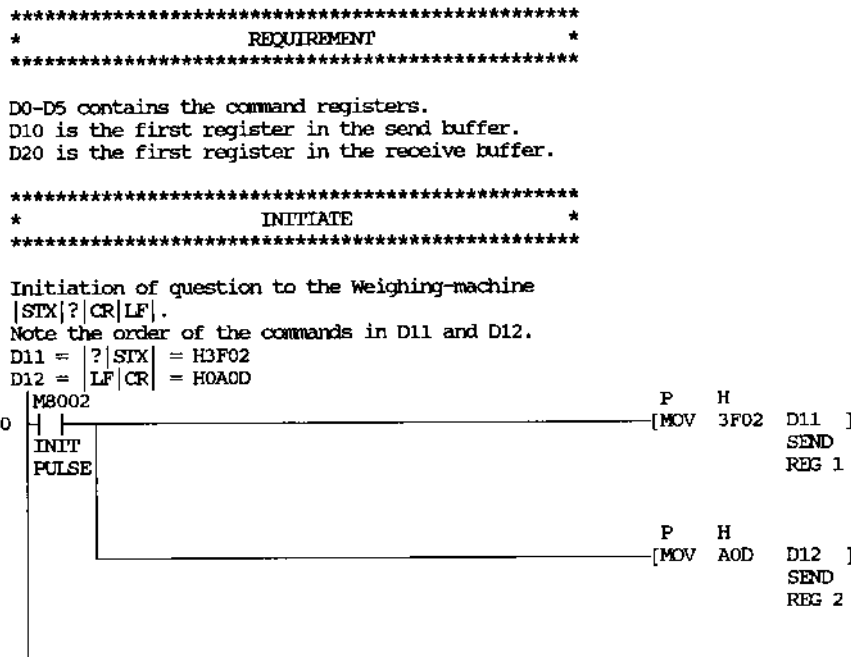

Initiation of command registers D0-D5.
 D0 = Start of the send buffer, K10 = D10.
 D2 = Start of the receive buffer, K20 = D20.
 D4 = End code |CR|LF|.
 D5 = 0, use end code.

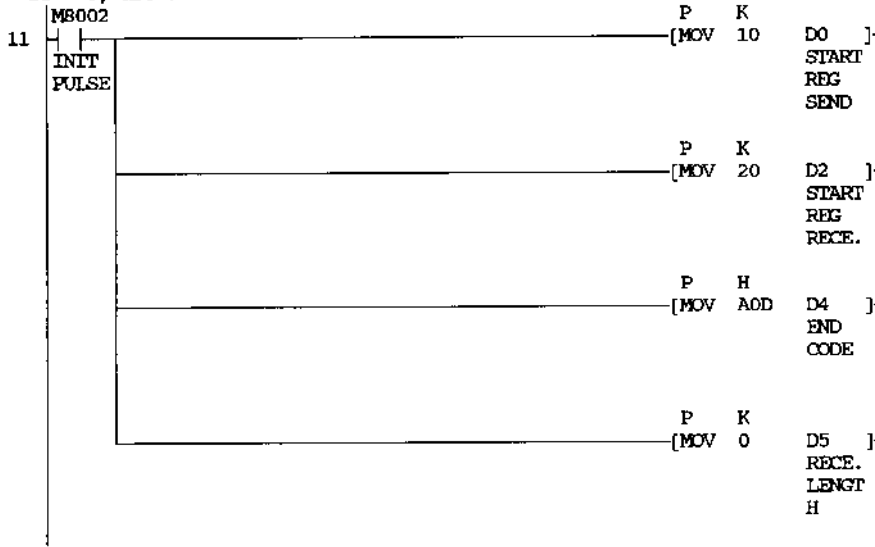

 * SEND/RECEIVE-SEQUENCE *

***** Step 0, wait *****

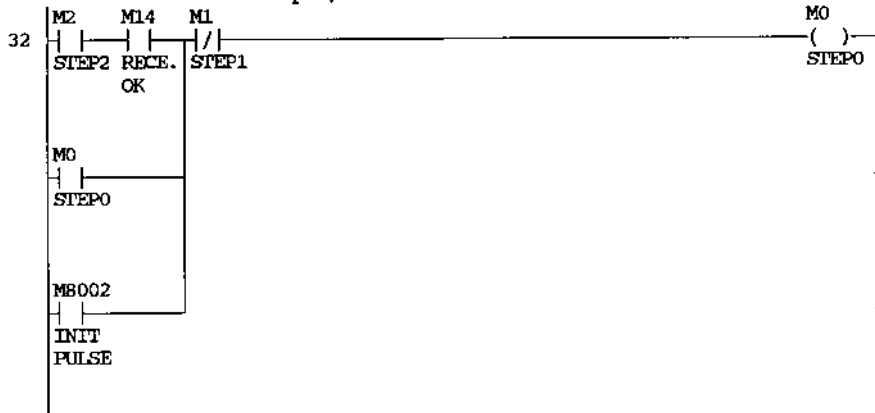

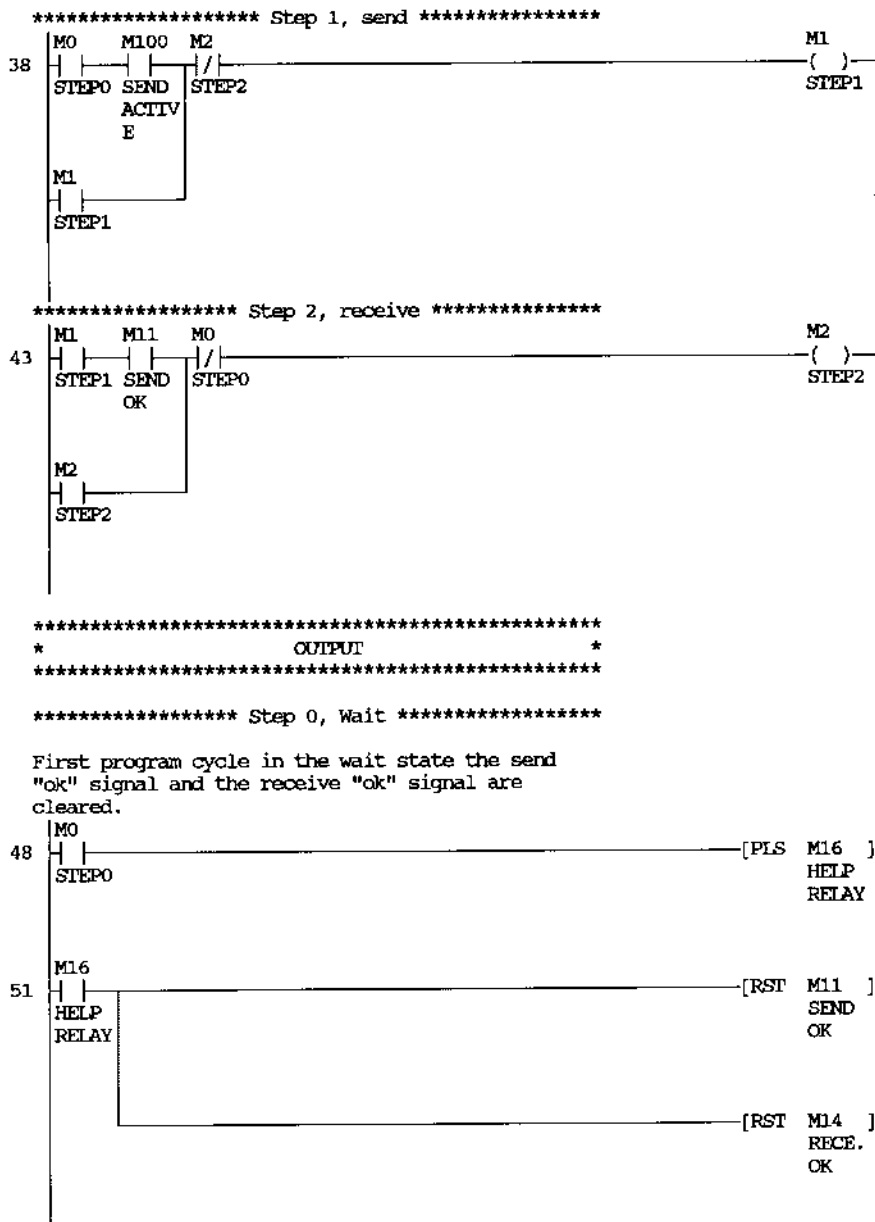

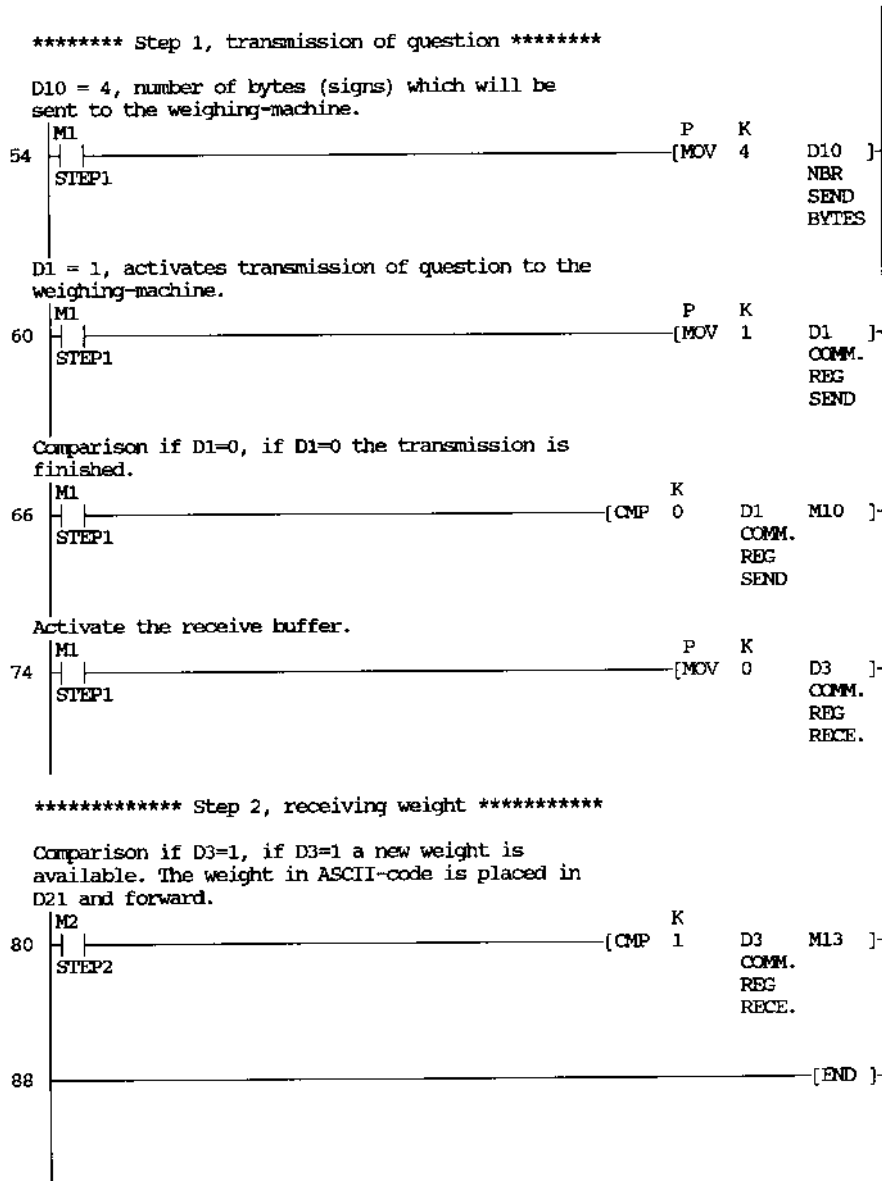

17.3 Modem connection

A modem can be used for making a connection to a personal computer. The settings for the connection are made in the **Modem Setting** dialog in the **Setup** menu.

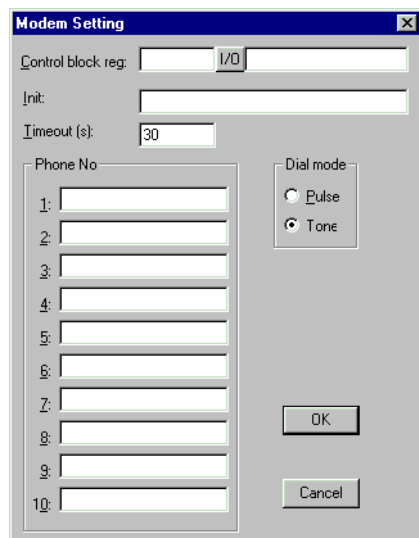

Control block reg:

The communication is established using three control registers in a control block. The first register in the control block is defined at Control block reg in the dialog. The function of the control registers is described in the table below.

Register	Description
Ctrl reg 0	<p>Contains the command describing how the PLC system shall call up and establish connection.</p> <p>0 Wait for command.</p> <p>1-10 Call up with the phone number entered in the field Phone No 1-10. Maximum 40 characters.</p> <p>11 Call up with a phone number stored in the PLC system. This phone number is stored as an ASCII string beginning in the third control register and then some following registers. The string can maximum contain 40 characters, i.e. 20 registers. All registers do not have to be used. The last register that shall be read must contain the ASCII code 0.</p> <p>101-110 An init string is sent to the modem. Enter Hayes modem commands in the fields Phone No 1-10. Command 101 sends the string in the field Phone No 1 etc.</p> <p>111 An init string stored in the PLC system is sent to the modem. Enter Hayes modem commands beginning in the third control register. See Command 11 for details.</p> <p>255 Hang up command.</p>
Ctrl reg 1	<p>The second control register is used as a status register. This register contains the result of the modem command. The status register can contain the following:</p> <p>Status codes</p> <p>0 Command executed successfully.</p> <p>1 Dial in progress.</p> <p>2 Modem established a connection.</p> <p>3 Modem detected a ring signal.</p> <p>Error codes</p> <p>101 No connection (when hanging up).</p> <p>102 Modem detected lost carrier.</p> <p>103 Unspecified error from modem.</p> <p>104 Modem gets no dial tone.</p> <p>105 Busy when dialling.</p> <p>106 No answer when dialling.</p> <p>107 No reply from modem.</p> <p>255 Unknown error/status.</p>
Ctrl reg 2	<p>The terminal can call up with a phone number stored in the PLC system. This phone number is stored as an ASCII string beginning in the third control register and then some following registers. The string can maximum contain 40 characters, i.e. 20 registers. All registers do not have to be used. The last register that shall be read must contain the ASCII code 0.</p>

Init:

Modem init string.

Timeout

Number of seconds before the line is disconnected at inactivity. Default is 30 seconds. Times between 5 and 600 seconds can be stated.

Dial mode:

Select between Pulse and Tone.

Phone No 1-10:

Complete phone number for call up. Maximum 40 characters.

18 Network communication

The chapter is not valid for E50.

This chapter describes how the operator terminals in the E series communicate in a network. The network communication takes place via TCP/IP (Transport Control Protocol/Internet Protocol). TCP/IP is a standardized set of protocols developed to allow cooperating computers to share resources across a network. The operator terminals can be connected in a network in many different ways. The connection can either be Ethernet or serial. If Ethernet is used the expansion cards IFC ETTP or IFC ETCX are required in all terminals. IFC ETTP is used to connect the terminals with twisted pair and IFC ETCX is used to connect the terminals with coaxial cable. If twisted pair is used an Ethernet HUB is required. For further information about TCP/IP please refer to the RFC's published on Internet. You will find them for example on this address:
`ftp://ftp.sunet.se/pub/internet-documents/rfc.`

Information and description of concept and words used can be found on the web address `http://www.whatis.com.`

The terminal network is a Client/Server network and works as follows. Only Clients can access data on the network. Servers only provide access for other Clients. A terminal can be both a Client and a Server to be able to provide access and also access other terminals. Up to 20 different Clients can access data from the same Server. A Client can access data from up to 16 different Servers.

Each terminal requires an IP address. Addresses from 192.168.0.0 to 192.168.254.254 are recommended for internal networks.

With the terminal you can use standardized Internet tools such as browser, mail server and FTP client. You can create a web site in a PC and load it to the terminal. The Web page can contain real time data from the PLC system or the terminal. Via Internet and a browser you can change values, set signals, acknowledge alarms etc via script.

The terminal can also send email at special events e.g. alarm and status report.

18.1 Examples of possible networks

Example 1

This Ethernet network is designed for one controller together with several terminals.

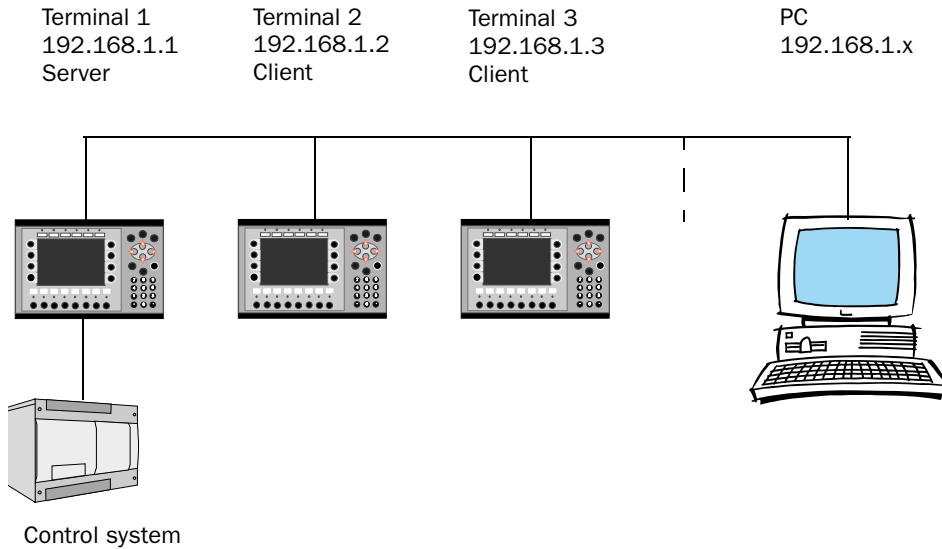

Terminal 1 (192.168.1.1)

Terminal 1 must be a Server. Clients can access the controller through the Server.

TCP/IP Network Connection

Connection name: Terminal 1

Host configuration: Manual

TCP/IP Settings:

IP Address: 192.168.1.1

Subnet mask: 255.255.255.0

Gateway: 0.0.0.0

Primary DNS: 0.0.0.0

Secondary DNS: 0.0.0.0

OK Cancel

Setup BDTP Server service

Server port: 6002

Max Clients: 8

Data register: [] I/O

Lock server

OK Cancel

Terminal 2 (192.168.1.2)

Terminal 2 must be a Client. A Client can access the controller connected to a Server.

The screenshot shows the 'TCP/IP Network Connection' dialog box. The 'Connection name' is 'Terminal 2' and 'Host configuration' is set to 'Manual'. Under 'TCP/IP Settings', the IP Address is 192.168.1.2, Subnet mask is 255.255.255.0, Gateway is 0.0.0.0, Primary DNS is 0.0.0.0, and Secondary DNS is 0.0.0.0. There are 'OK' and 'Cancel' buttons at the bottom.

The screenshot shows the 'Setup BDP Client service' dialog box. Under 'General setup', the BDP Server port is 6002 and the Default BDP Server is 'None'. There are input fields for 'Data register' and 'Control block', both with 'I/O' buttons. The 'Synchronize clock with server' checkbox is checked, and the server is set to '1'. Under 'BDTP Server connections', the BDP Server Address is 192.168.1.1. A table lists the server connections:

Index	BDTP Server
1	192.168.1.1

Buttons for 'Update', 'Append', and 'Delete' are to the right of the table. 'Ok' and 'Cancel' buttons are at the bottom.

Terminal 3 (192.168.1.3)

Terminal 3 must be a Client. A Client can access the controller connected to a Server.

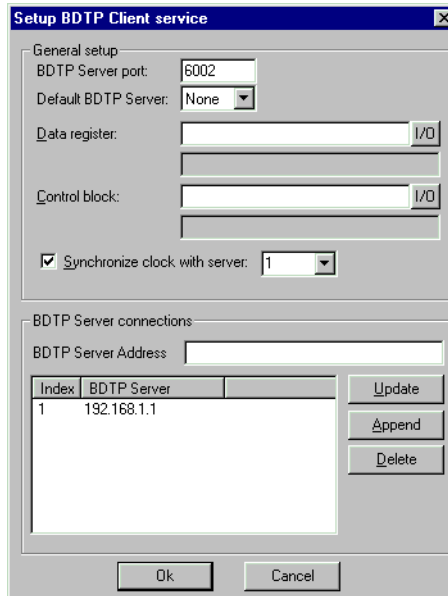
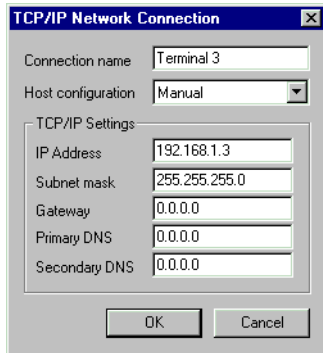

A PC can be connected for transferring projects to the terminals. The PC can be connected either via an Ethernet card or to one of the serial ports on one of the terminals using CAB5 or CAB6. The Ethernet card is recommended.

Example 2

This Ethernet network is designed for several controllers and operator terminals in one network. The controllers in this example use different protocol drivers.

The following Client/Server and Driver configuration gives following access. This example uses two drivers, driver X and driver Y.

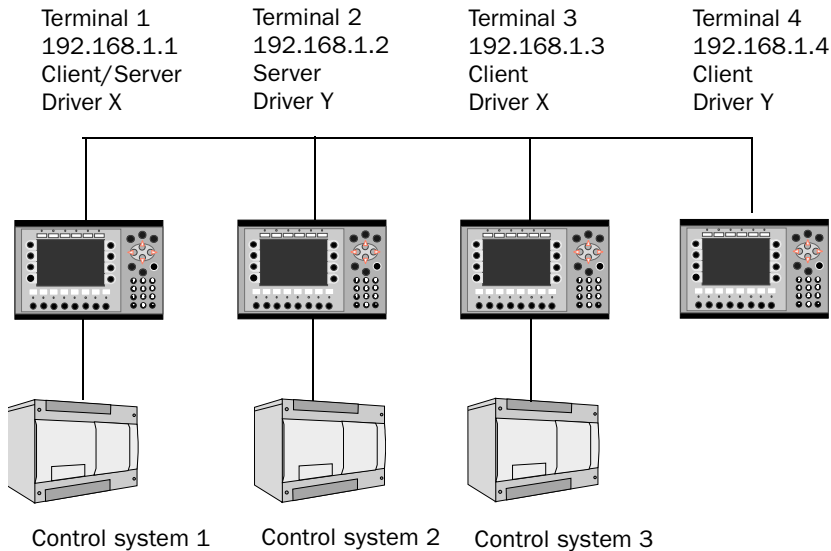

Terminal 1 (192.168.1.1)

Terminal 1 is a Client with driver X and can access all the Servers with the same driver. It can also access its local controller 1. In this example terminal 1 only has access to controller 1. It can't access controller 2 because of different drivers and not controller 3 because the terminal 3 is not a Server.

Terminal 2 (192.168.1.2)

Terminal 2 is not a Client and can't access any other stations in the network. It can only access its local controller 2.

Terminal 3 (192.168.1.3)

Terminal 3 is a Client with driver X and can access all Servers with the same driver. It can also access its local controller 3. In this example terminal 3 only has access to controller 1 and 3. Terminal 3 can't access controller 2 because of different drivers.

Terminal 4 (192.168.1.4)

Terminal 4 is a Client with driver Y and can access all Servers with the same driver. In this example terminal 4 only has access to controller 4 only. Terminal 4 can't access controller 1 because of different drivers and not 3 because it is not a Server.

Data between the controllers can be exchanged with a small controller program or using function keys. See BDTP Client and BDTP Server.

Example 3

This Ethernet network is a normal configuration where a PC is included. This allows the computer to access any terminal in the network and transfer a project. The PC can be connected either via an Ethernet card or to one of the serial ports on one of the terminals using CAB5 or CAB6. The Ethernet card is recommended. The example assume that the same driver is used. To change PLC system we refer to the sections BDTP Client and BDTP Server.

Terminal 1 192.168.1.1 Server/Klient	Terminal 2 192.168.1.2 Server/Klient	Terminal 3 192.168.1.3 Klient	Terminal 4 192.168.1.4 Klient	Persondator 192.168.1.X
--	--	-------------------------------------	-------------------------------------	----------------------------

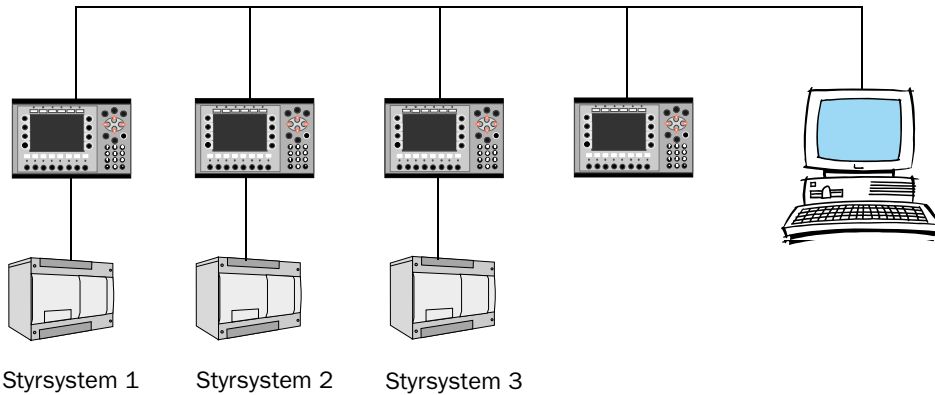

Terminal 1 (192.168.1.1)

Terminal 1 is a Client and can access all the Servers. It can also access its local controller 1. This means that it has access to controller 1 and 2.

Terminal 2 (192.168.1.2)

Terminal 2 is a Client and can access all the Servers. It can also access its local controller 2. This means that it has access to controller 1 and 2.

Terminal 3 (192.168.1.3)

Terminal 3 is a Client and can access all the Servers. It can also access its local controller 3. This means that it has access to controller 1 and 2.

Terminal 4 (192.168.1.4)

Terminal 4 is a Client and can access all the Servers. This means that it has access to controller 1 and 2.

Data between the controllers can be exchanged with control registers. See BDTP Client and BDTP Server.

Note!

When a project is transferred to a terminal this station will stop communication momentarily. If the terminal is a Server all the clients requesting data from this Server will receive an error message.

Example 4

When only two stations are to be used a connection can be established with serial communication. This setup uses the built-in serial port to connect to the second terminal. No Ethernet card is required.

One or two controller can be used with this "network". Both the controller systems in the network uses the same driver and both the terminals have access to both the controller system 1 and 2.

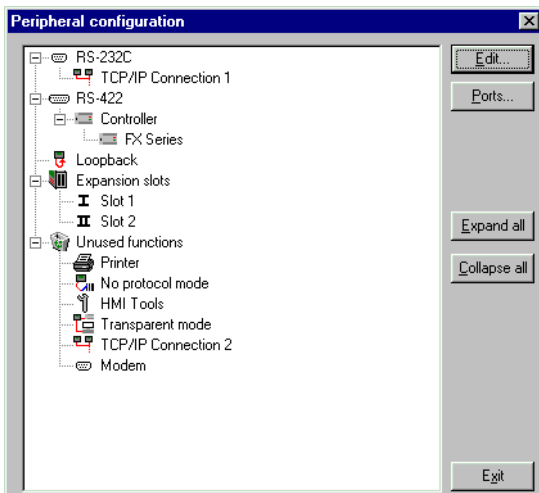
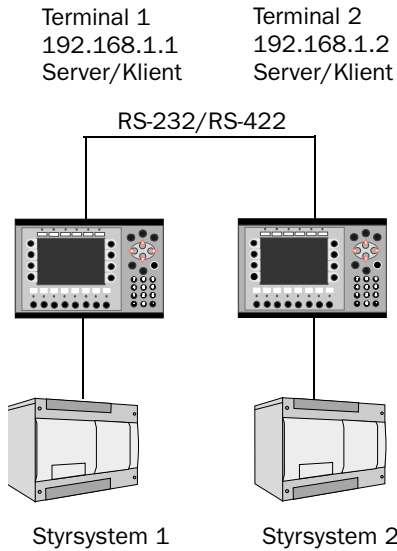

Terminal 1 (192.168.1.1)

Terminal 1 is a Client and can access the other Server. It can also access its local controller 1. This means that it has access to controller 1 and controller 2.

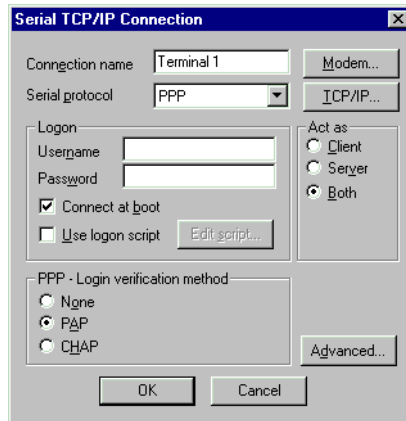

Serial TCP/IP Connection

Connection name: Terminal 1 [Modem...]

Serial protocol: PPP [TCP/IP...]

Logon:

Username: []

Password: []

Connect at boot

Use logon script [Edit script...]

Act as:

Client

Server

Both

PPP - Login verification method:

None

PAP

CHAP

[Advanced...]

[OK] [Cancel]

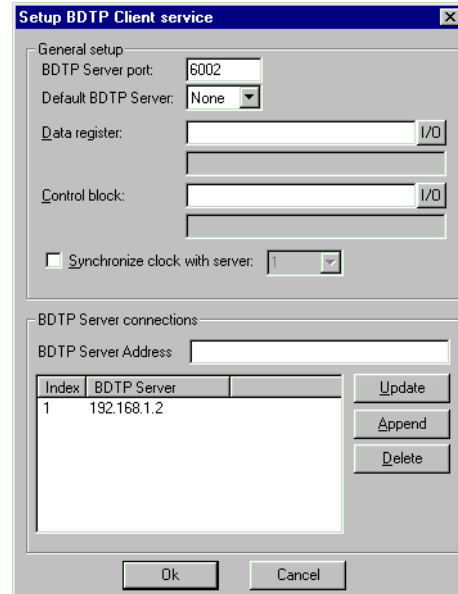

Setup BDTF Client service

General setup:

BDTF Server port: 6002

Default BDTF Server: None

Data register: [] [I/O]

Control block: [] [I/O]

Synchronize clock with server: []

BDTF Server connections:

BDTF Server Address: []

Index	BDTF Server
1	192.168.1.2

[Update]

[Append]

[Delete]

[Ok] [Cancel]

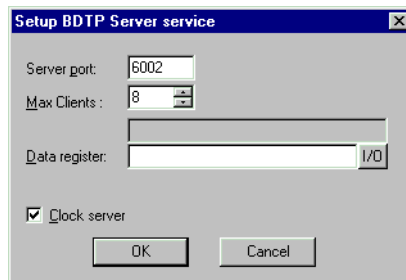

Setup BDTF Server service

Server port: 6002

Max Clients: 8

Data register: [] [I/O]

Clock server

[OK] [Cancel]

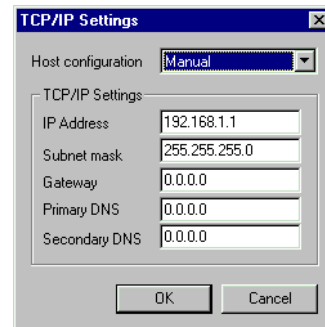

TCP/IP Settings

Host configuration: Manual

TCP/IP Settings:

IP Address: 192.168.1.1

Subnet mask: 255.255.255.0

Gateway: 0.0.0.0

Primary DNS: 0.0.0.0

Secondary DNS: 0.0.0.0

[OK] [Cancel]

Terminal 2 (192.168.1.2)

Terminal 2 is a Client and can access the other Server. It can also access its local controller 2. This means that it has access to controller 1 and controller 2.

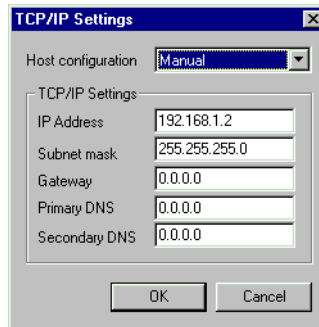
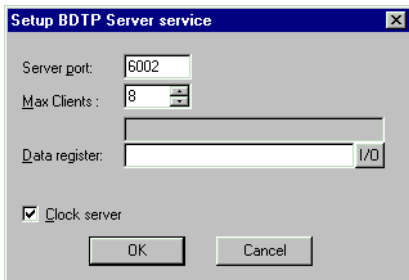
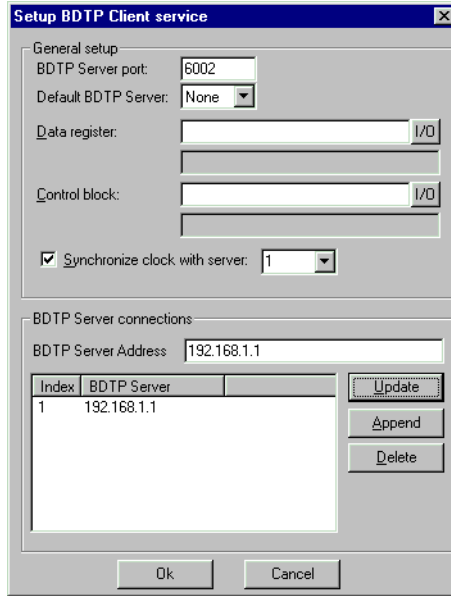
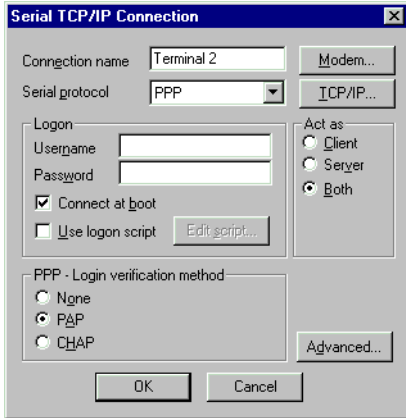

18.2 Network communication via ETHERNET

You need one of the expansion cards, IFC ETTP or IFC ETCX, in the terminals to connect the terminals to a TCP/IP network via ETHERNET. IFC ETTP is used for connection via pair twisted cable and IFC ETCX is used for connection via coaxial cable.

How to make a connection

Install the IFC ETTP or IFC ETCX card according to the manual for this cards. Select **Peripherals** in the **Setup** menu. Mark the selected expansion slot and click the right mouse button. Select network card. Mark **TCP/IP connection** and keep the left mouse button pressed. Then drag the mouse to selected expansion card and release the mouse button.

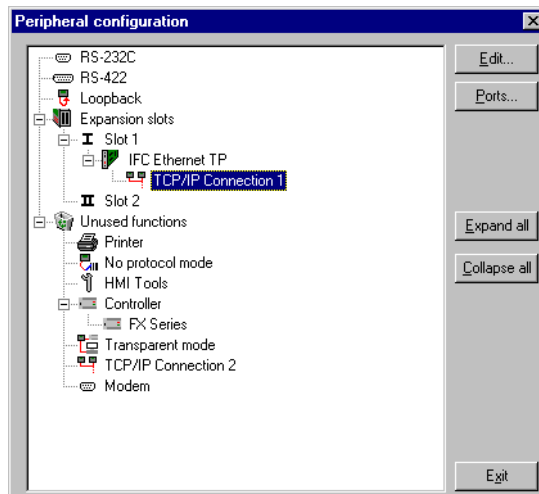

Settings

The settings for the serial connection are made in the dialog shown when the connection is selected and you press **Edit....**

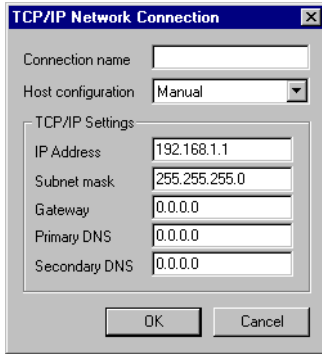

Connection name

Enter freely a name of the connection. The parameter doesn't need to be stated.

Host configuration

Manual means that the settings of the TCP/IP parameters made in the dialog are used. The other alternatives mean that the terminal provides one or several of the TCP/IP parameters from a network server.

IP-adress

State the IP address of your node. For information about which IP address to use please refer to your network manager or to the RFC's from the Internet committee. If you are using a local network between the terminals we recommend you use the addresses 192.168.1.1 – 192.168.1.254.

Subnet mask

State your network identity.

Gateway

State the network unit in the local network that can verify the identifiers for the other networks on Internet.

Primary DNS and Secondary DNS

State the servers containing information about a part of the DNS data base.

ETHERNET connections

The section below shows three examples of ETHERNET connections between two terminals.

Connection between two terminals via pair twisted cable (TP)

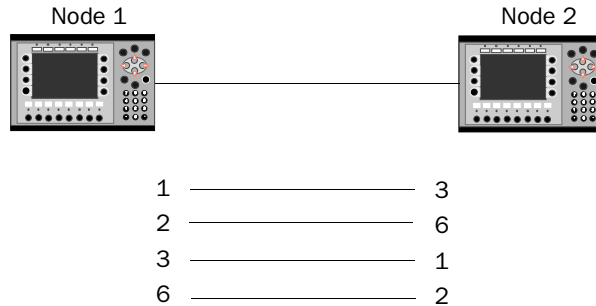

The cable has RJ45 connectors. The cable is a CAT5 (cross coupled) pair twisted cable, screened or not screened.

Note!

If the communication doesn't work properly, and the LED marked Link on the IFC ETTP card doesn't light, connections 3 and 6 are probably switched.

TCP/IP settings in the nodes

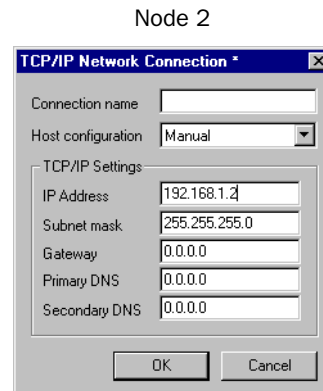
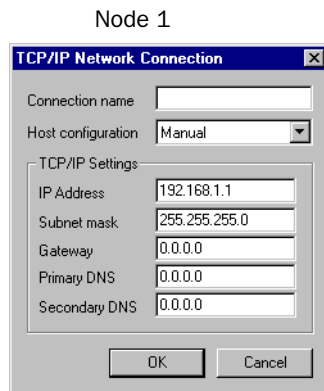

Connection between more than two terminals via pair twisted cable (TP)

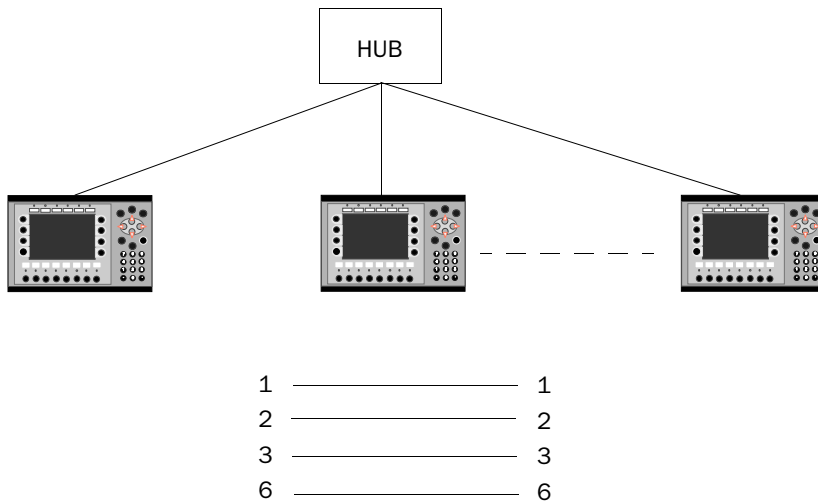

The maximal length between the terminal and the HUB is 100 m. The maximal number of terminals per HUB are limited by the number of connections on the HUB. The cable has RJ45 connectors. The cable is a CAT5 pair twisted cable, screened or unshielded.

TCP/IP settings in the nodes

Node 1

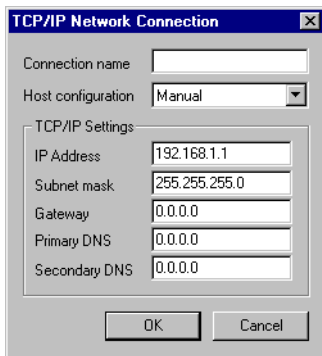

Node 2

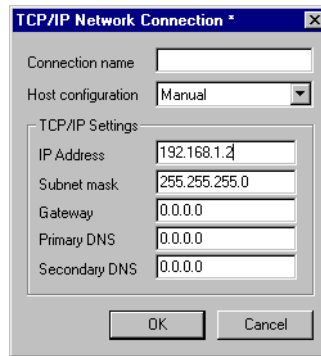

Connection via coaxial cable

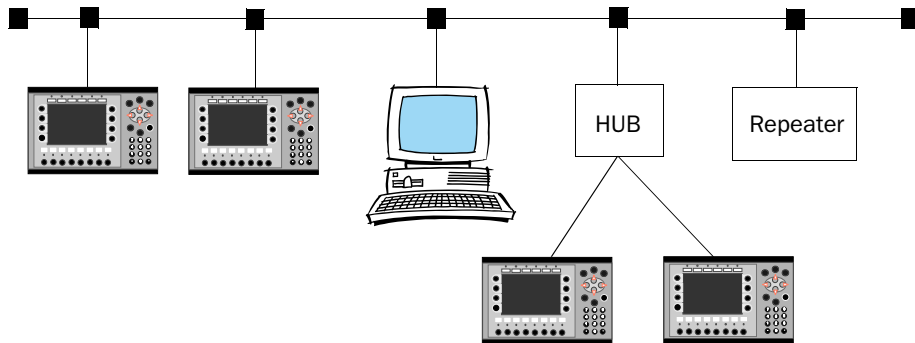

In the network the coaxial cable RG58 is used. There must be bus endings of 50 Ohm. Several coaxial cables can be connected with repeaters to get longer networks. The network will then comprise different segments.

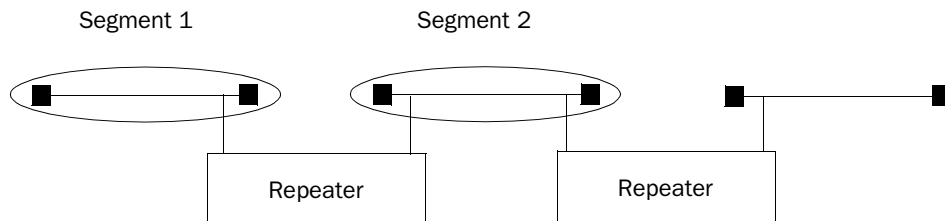

The maximum length of a segment is 185 m and the maximum number of units/segment is 30. Four repeaters can be serial-connected, which means that five segments may be serial connected. Only three of the segments can have units connected. This means that there must be at least two empty segments in the network. For more information see RFC on the Internet.

TCP/IP settings in the nodes

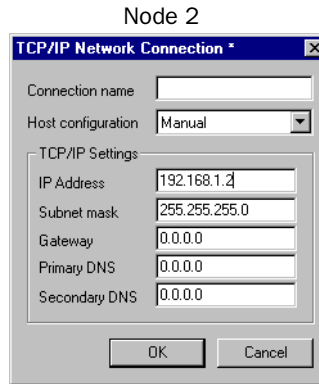
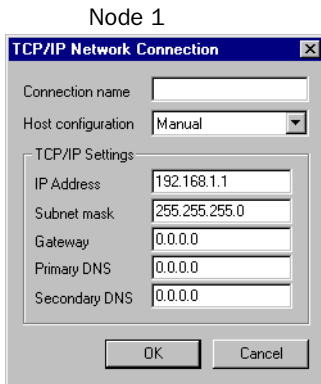

18.3 Serial network communication

How to make a connection

Select **Peripherals** in the **Setup** menu. In the dialog **Peripheral configuration** you mark TCP/IP connection and keep the left mouse button pressed. Then drag the mouse to RS-232 or RS-422 and release the mouse button.

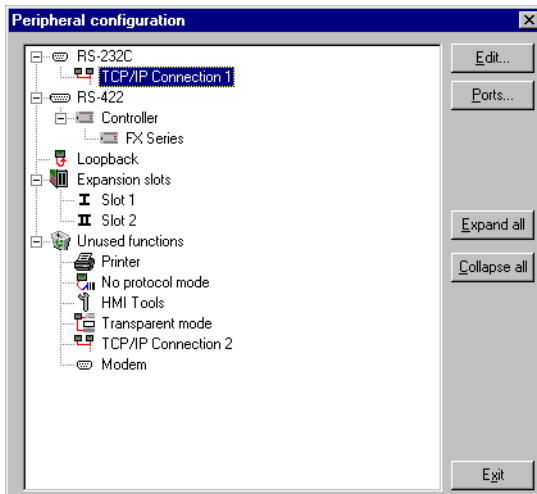

Settings

The settings for the serial connection are made in the dialog shown when the connection is selected and you press **Edit...**

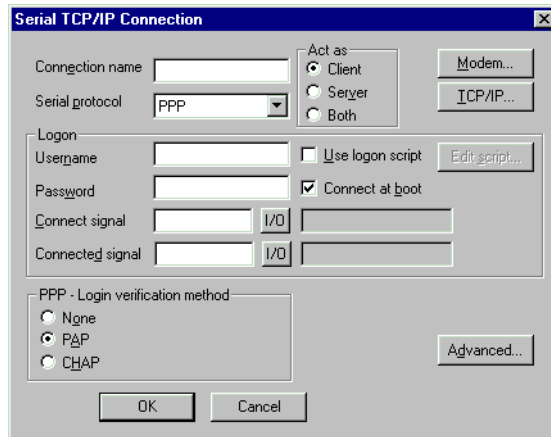

Connection name

Enter freely a name for the connection. The parameter doesn't need to be stated.

Serial protocol

For serial communication you can select protocol PPP.

User name

State the username used at login.

Password

State the password used at login.

Connect signal

Digital signal which establish the connection when it is set and disconnect when it is reset.

Connected signal

Analog register which can have the following status.

- 0 Disconnected (PPP Client)
- 1 Waiting for a connection (PPP Server)
- 2 Connected as a PPP Client
- 3 Connected as a PPP Server
- 7 Connection error

Use logon script

The function is used to automatize a serial login. The script will look different depending on which server and modem you connect to. The terminal support the following commands.

- 1. WAIT: Text , x Wait for the text Text for x seconds. x must not be stated
- 2. SEND: Text Sends the text Text
- 3. LABEL: Label Label become a reference point in the script.
- 4. ONERR: Label Jumps Label when an error occur in previous command.
- 5. MESSAGE: Message Shows a message box with the message Message.
- 6. END: End the script.
- 7. SLEEP: x Sleeps in x seconds.
- 8. COUNTER: y Count up a counter each time the script passes "COUNTER:". If the value y is reached an error occur. This error is handled by "ONERR:".

Variables:

- %USERNAME Compare with the names in accounts.
- %PASSWORD Compare with the passwords in accounts.

Example 1:

```
WAIT: login:, 10
SEND: JOHN
WAIT: password:,10
SEND: HELLO
```

Example 2:

The following script sends the text "CLIENT". If the send failed a message box with the text "Send Failed" is displayed. If the send succeeded we wait for the text "CLIENTSERVER" for 10 seconds. If it doesn't appear a message box with the text "Receive Failed" is displayed.

```
SEND: CLIENT
ONERR: Send Failure
WAIT: CLIENTSERVER,10
ONERR: Receive Failure
END:
LABEL: Send Failure
MESSAGE: Send Failed
END:
LABEL: Receive Failure
MESSAGE: Receive Failed
END:
```

Example 3:

The following script sends the text "login:" and then wait for the receiver to send a user name. It is checked if the name match a username in accounts. Then the script sends the text "password:" and wait for the receiver to send a password. It is checked in accounts if the password match the password for the sent user name.

Normally no script is needed. If you connecto to a Windows NT server the script shall be as follows.

```
SEND: login:
WAIT: %USERNAME
SEND: password:
WAIT:%PASSWORD
```

PPP - Login verification method

Select method to assure the user identity. Doesn't normally need to be changed. This parameter is used only at PPP connection.

Act as Client/Server

At PPP connection you select if the terminal shall act as a PPP client or PPP server. The terminal can both call and be called.

Advanced

Under **Advanced** you can define further parameters.

Use VJ compression of IP header

Compression of the IP head. Doesn't normally need to be changed. This parameter is used only at PPP connection.

Request/Provide remote address

Request/provide the IP address for the remote node. Shall be 0.0.0.0 if you want to request the IP address from the remote node. This parameter is used only at PPP connection.

Request/Provide local address

Request/provide the local IP address. Shall be 0.0.0.0 if you want to request the IP address from the remote node. This parameter is used only at PPP connection.

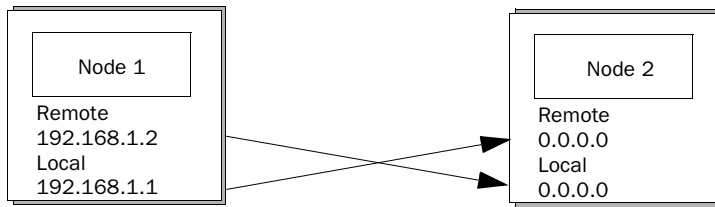

Set remote address as gateway

Mark if you want the remote node address to be a gateway, connection port to another network. Default is OFF. The parameter is used only in PPP connection.

Modem

The parameters under **Modem setup** are stated if the connection shall take place via a modem.

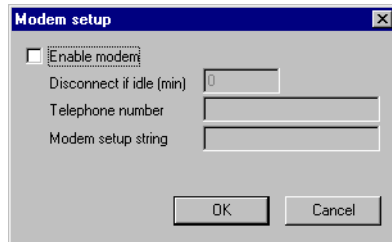

9-pol female		25-pol male
2	_____	2
3	_____	3
5	_____	7
7	_____	8
8	_____	4

Telephone number

State the telephone number to be called.

Modem setup string

A setup string which initializes the modem. For further information please refer to the documentation for the modem.

TCP/IP

Parameters for the TCP/IP connection.

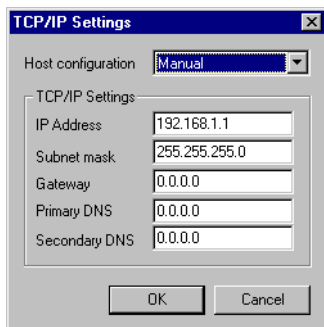

IP-adress

State the IP address of your node. For information about which IP address to use, please refer to your network manager or to the RFC's from the Internet committee. If you are using a local network between the terminals we recommend you use the addresses 192.168.1.1 – 192.168.1.254.

Subnet mask

State your network identity.

Gateway

State the network unit in the local network that can verify the identifiers for the other networks on Internet.

Primary DNS och Secondary DNS

State the servers containing information about a part of the DNS data base.

Serial connection

A PPP connection between two terminals

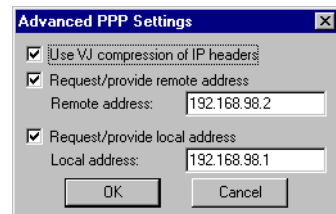
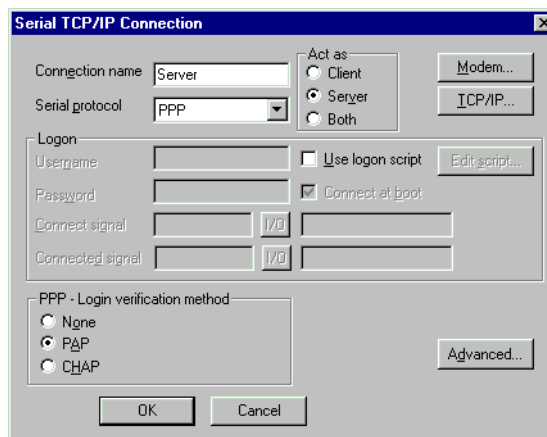
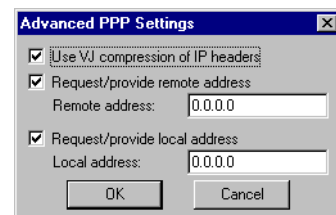
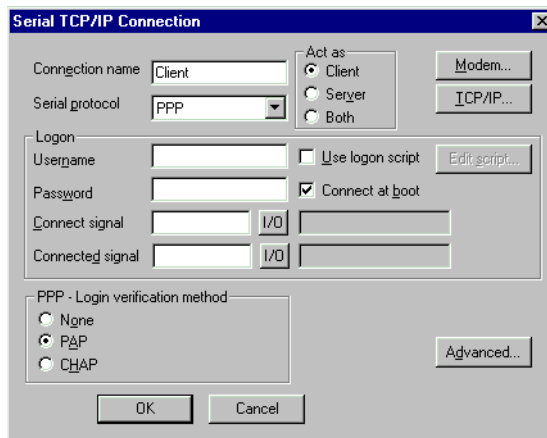
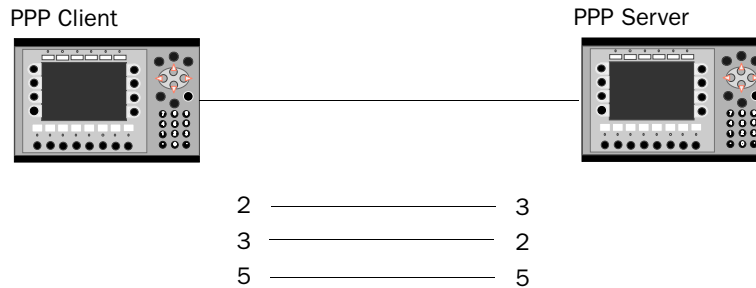

The settings under TCP/IP IP Address, Subnet mask and Gateway have no meaning. PPP will change these parameters.

A PPP connection between a terminal and a personal computer

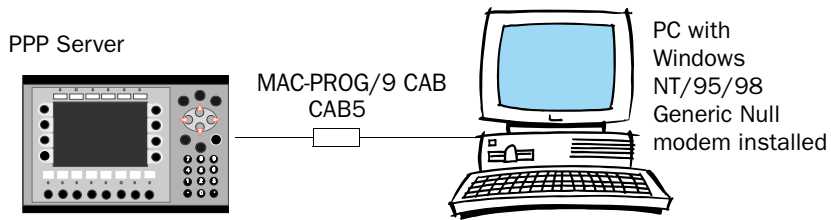

Settings in the terminal

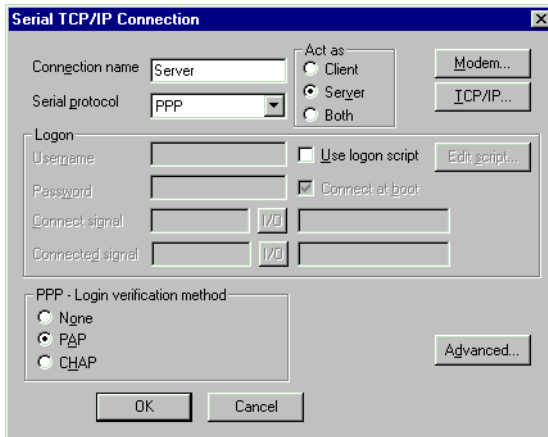

The settings under TCP/IP, IP Address, Subnet mask and Gateway have no meaning. PPP will change these parameters. Note that if PAP is selected as Login verification method User name and Password must be stated.

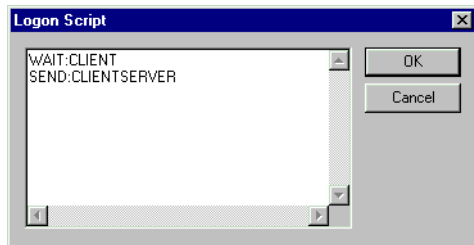

PC settings

The figures below shows the settings in the different dialogs when creating a serial PPP connection between a PC and a terminal. In this document we assume that the user has installed a Generic Null modem and defined a port for serial cable for Dial-up networking.

Select the function **New connection** according to the following path:

Start\Programs\Accessories\Dial-up Networking\New connection

The following dialog is shown. Make the settings according to the following figure.

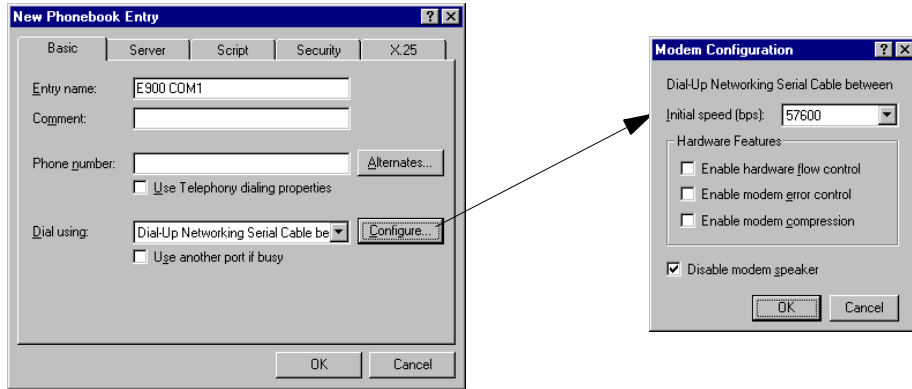

Click on the file tab **Server** and make the following settings.

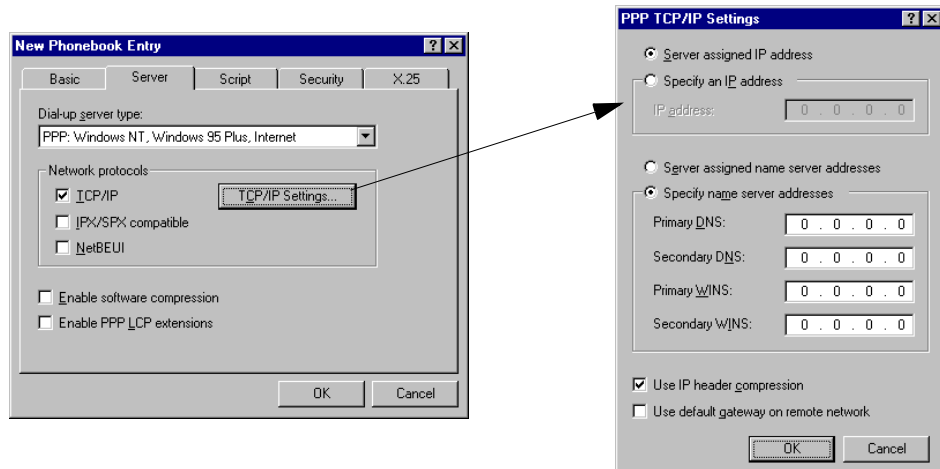

Click on the file tab **Script** and make the following settings.

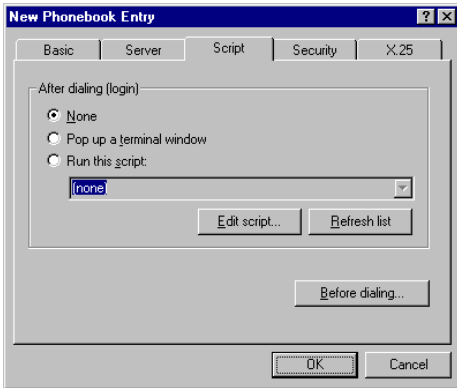

Click on the file tab **Security** and make the following settings.

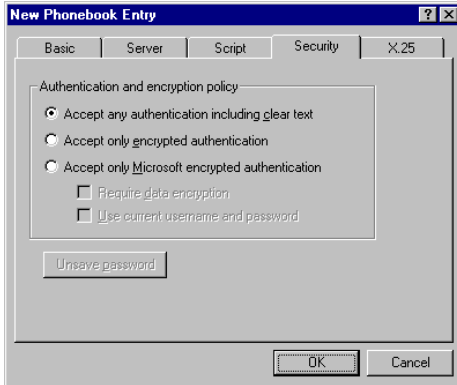

Click on the file tab **X 25** and make the following settings.

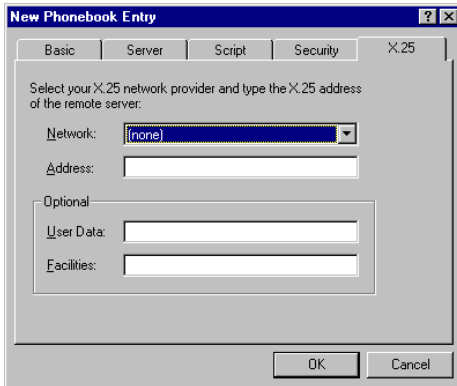

Now the settings is done. To establish communication you select the function Dial-up networking. Enter the defined post name and select Dial-up.

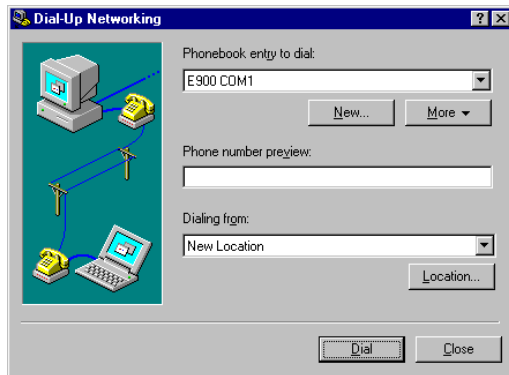

In the following dialog you shall confirm the call-up. Press OK.

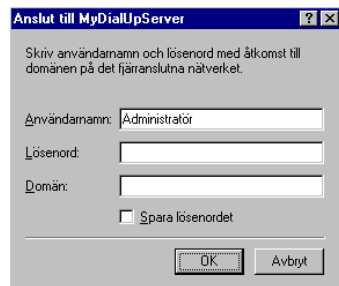

18.4 Network services

Under **Network/Services** in the **Setup** menu you select the services the terminal shall provide from the network. Select current function and click on **Edit...**

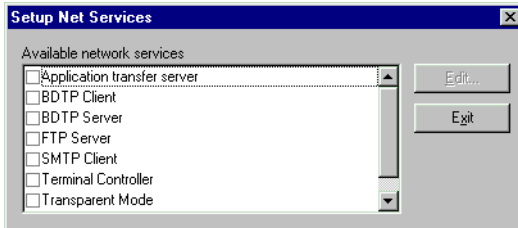

Application transfer server

Function for transferring a project via TCP/IP. Press Edit and enter the number of the port that will enable the transfer. Doesn't normally need to be changed.

BDTP (Beijer Data Transport Protocol)

BDTP (Beijer Data Transport Protocol) replaces the old MAC network. The BDTP server will listen for I/O request from the BDTP client. The terminal can be client, server or both. The client can get data from max 16 servers. The IP addresses of the servers are stated in the BDTP client.

Network communication via BDTP is used to connect more than two terminals to a PLC system and maintain good performance. An example of use is production lines, where you need one terminal at each workstation.

The figure below shows an example of a network.

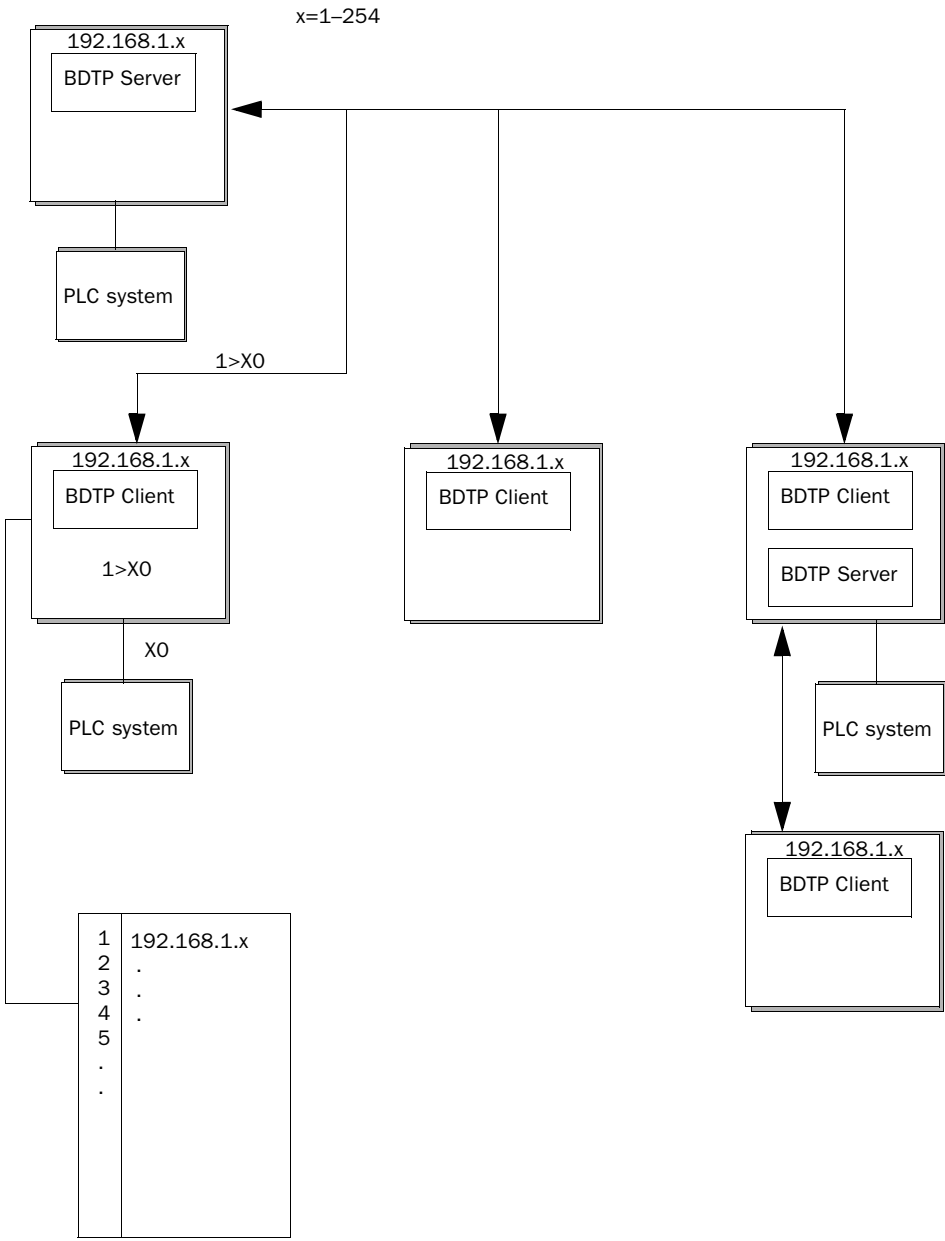

BDTP Client

In the **Network service BDTP Client** you define IP-addresses for those BDT servers from which the client can retrieve information. When you press **Edit** the following dialog is shown.

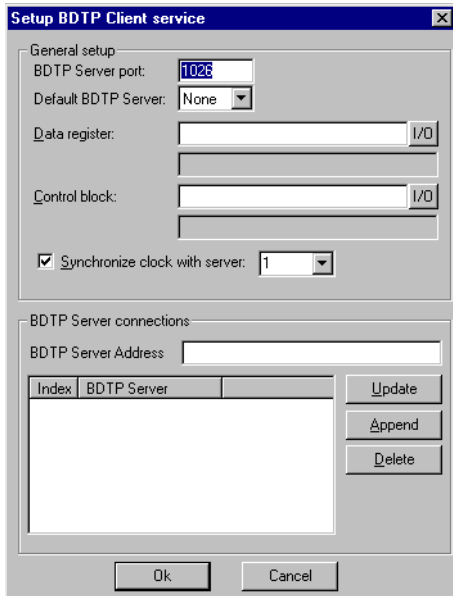

BDTP Server port

State the communication port to which the BDTP server/network is connected. Doesn't normally need to be changed.

Default BDTP Server

Here you can specify a default BDTP server. If you don't specify the address the client will get the value from the default server.

Data register

Values in data registers can be transferred between one client and different servers in a network. Under Data register you state the first register in the register block in the client to be transferred to/from the stated server. The type of register must not be the same in the client and the server.

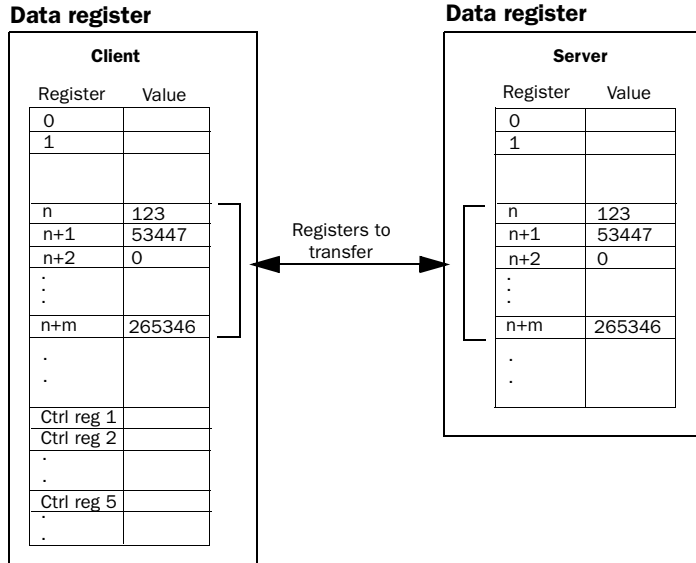

Control block

Under Control Block you state the first register in the control block in the client. The control block takes five registers as follows.

Register	Content	Description
Ctrl reg 1	Command	Command register which is set in the client. Available commands: 0: No command. 1: Transfer register values from the client to the server stated in control register 3. 2: Transfer register values from the server stated in control register 3 to the client.
Ctrl reg 2	Handshake	Handshake register which is set by the client. 0: Ready for a new command. 1: OK 2: Transfer failed.
Ctrl reg 3	Server index	The number of the server in the network handling the transfer.
Ctrl reg 4	Index register	The value in the index register is added to the address off the register stated under Data register. If zero is stated in the register block will start with the address stated under Data register.
Ctrl reg 5	Number of registers	The number of registers which values shall be transferred to/from the stated server.

The transfer handling must take place according to the following:

1. The handshake register must be 0. If it is not, make sure that the command register is set to 0.
2. Write the command in the command register.
3. Wait for completion or error code in the handshake register.
4. Set the command register to 0. After this, the terminal will set the handshake register to 0.

Synchronize clock with server

State if the clock in the client shall be synchronized with selected server. Select server by stating the number of the server in the entry field. If the clock in the client is locally changed, the change is transferred to selected server.

BDTP Server Address

Under BDTP Server Address you define the addresses to the servers from which the client can retrieve information. The addresses will be indexed in the order they are stated.

When the object is defined in the project you must specify the source server for the address. Specify the following in the address field of the object:

server index>device

If, for example 2>D15 is entered in the address field the value for the object is loaded from register D15 in server 2.

It is possible to change the server index in a client project with the function BDTP Station change. See "Change BDTP station" on page 63.

BDTP Server

Handles the request from clients. Press **Edit** and state port. Doesn't normally need to be changed.

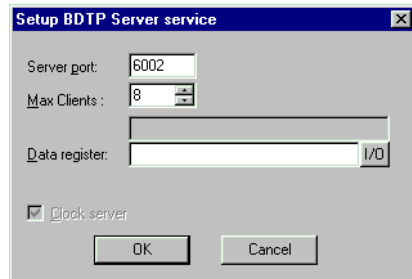

Data register

Values in data registers can be transferred between one server and different clients in a network. Under Data register you state the first register in the register block in the server to be transferred to/from the stated client. The type of register must not be the same in the client and the server. For further information about data transfer see the section BDTP Client.

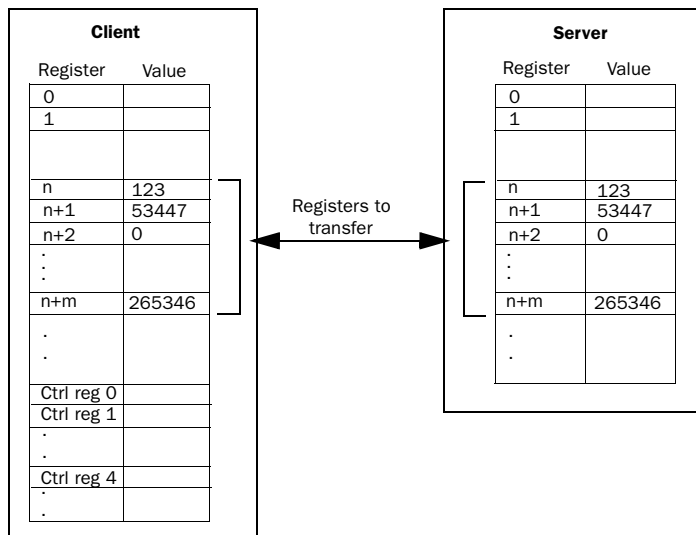

Note!

It is only possible to control data transfer from clients.

Clock Server

State if the clients in the network shall synchronize with the clock in current server. See also the section BDTP Client.

FTP Server

With this function it is possible to fetch and leave files to and from the terminal. The FTP server in the terminal allows transfer in passive mode (PASV). Passive mode should be used if you **don't** connect the terminal point-to-point. You don't always know what's between the client and the server, for example router based fire wall or gateways. By using passive mode you eliminate several errors. Browsers always use this mode. It is possible to use passive mode at point-to-point connection. National characters are not supported.

Select **FTP Server** under **Network services** and click on **Edit...** to make the settings for the function.

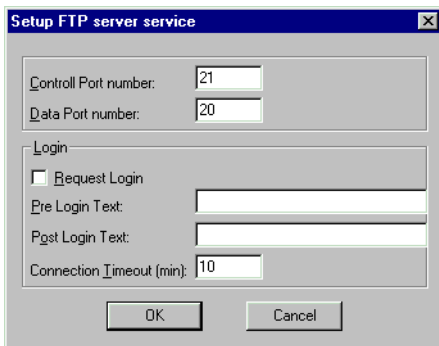

Control Port number

Default is 21 and should not be changed.

Data Port number

Default is 20 and should not be changed.

Request Login

Here you state if the user must login to get access to the FTP server. Users are defined under Accounts. If you select that no user need to login all users has full access to the FTP server.

Pre Login Text

A text shown before request of user is shown.

Post Login Text

A text showing when the user has logged in.

Connection Timeout

The time the FTP connection may be inactive before the server disconnect the connection. Default is 10 minutes.

Accounts

Under **Accounts** you define user accounts with which you decide if the user will have access to the FTP server.

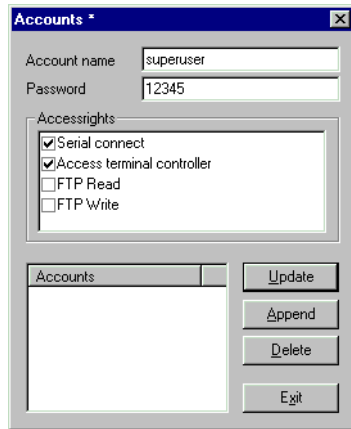
**FTP Access (Read)**

The user may use the FTP server (read).

FTP Write

The user may write to the FTP server. Require Access.

SMTP Client

The function makes it possible to send email from the terminal. Trend and recipe files can be send as attach files to the message. Max 20 messages can be sent at the same time. Select **SMTP Client** under **Network services** and click on **Edit...** Then you make the following settings.

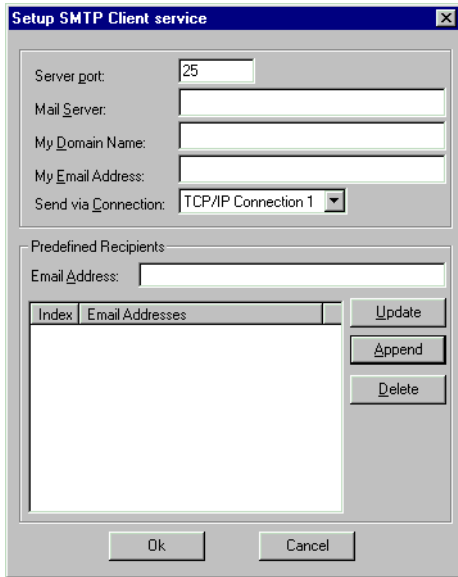

Server port

Connection port 25.

Mail server

The IP-address or the alias name (DNS server) for the SMTP mail server.

My Domain Name

The domain name of the terminal or any other used to login on the SMTP server.

My Email Address

Enter your email address. The name is shown as sender for the receiver. Please enter a real email address so that the mail server can return any error messages.

Send via Connection

State the connection used for sending. Note that Connection 1 must be used before Connection 2 can be used.

Recipients

A predefined list of max 16 receivers. A receiver address can be max 60 characters long.

Alarm via email

In the same way as alarm can be printed they can be sent as email. The whole alarmlist will be sent if you send block 990 (see Block Mail Report).

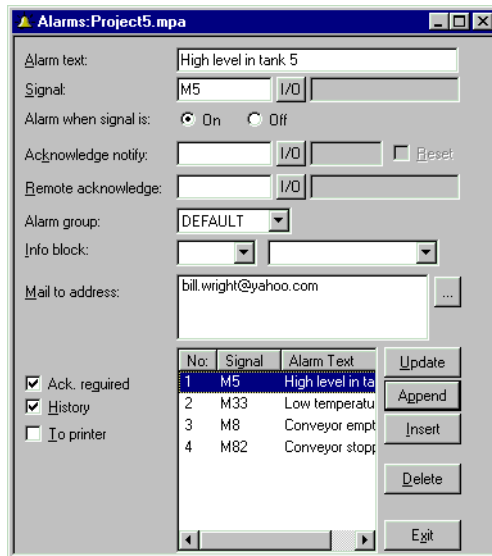

Mail to address

Enter the receiver of the message. Select up to eight receivers from the predefined list in the SMTP Client Service dialog.

Info block

If you state an information block and it is a textblock it will be included in the message. For more information see "Alarm handling".

Report via email

In the same way as textblock can be printed they can be sent as email.

Note!

Only textblock can be sent. Only the alarm block,990, of the system block are sent as email. Trend and recipe files are sent as attach files.

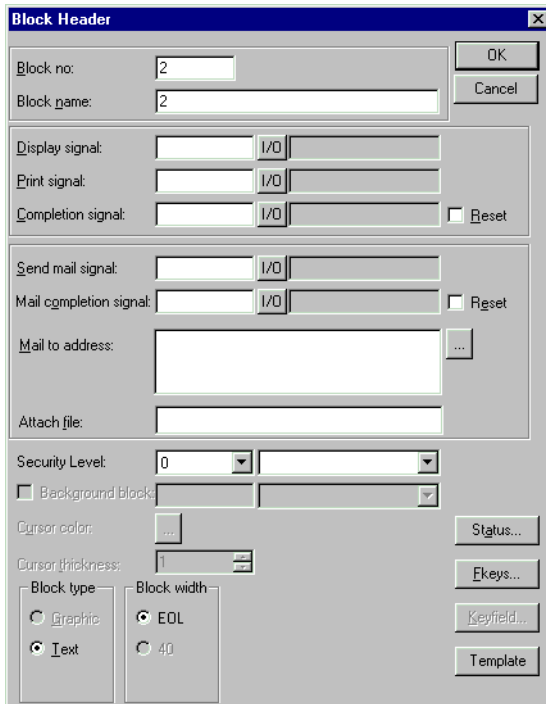

Block name

If you enter a name of a textblock it will be sent as a message/subject.

Send mail signal:

The message is sent when stated signal is set.

Mail completion signal:

A digital signal which is activated by the terminal when the message is sent. Normally the signal is set. If you mark the function Reset the signal will be reset when the message is sent.

Mail to address:

Enter the email address to the receiver. Select up to eight receivers from the list shown when you click on the ...-button. The list of email addresses are defined in the dialog **SMTP Client Service** under **Network Services** in the **Setup** menu.

Attach file:

Enter a name of a trend or recipe file to be attach with the message. If there are a trend file and a recipe file with the same name the trend file will be attach. The file name may not contain national characters.

Email via system block

By making a jump to the system block Mail, 993, you can write and send a mail during run-time.

E700

The screenshot shows a 'Send E-mail' dialog box with the following content:

Send E-mail to:
 1: bill@hotmail.com
 2: bob@yahoo.com
 3:
 4:
 5:
 6:
 7:
 8:
 Subject: Sodium
 Hi,
 We are running out of sodium here.
 /Rob

On the right side of the dialog, there are four vertically stacked buttons: LIST, CLR, SEND, and OK.

E710

This screenshot shows the 'Send E-mail' dialog box with the same recipient list as E700. At the bottom right of the dialog, there is a small downward-pointing arrow button.

The screenshot shows a virtual keyboard interface. The top of the keyboard has a search bar containing 'bob@yahoo.com_'. The keyboard layout includes the following keys:

A	B	C	D	E	F	G	H	ESC
I	J	K	L	M	N	O	P	<-
Q	R	S	T	U	V	W	X	CLR
Y	Z	Å	Ä	Ö		MAIL	DEL	
a-z	0-9	SPC		<<	>>	<J		

Send E-mail to

Enter the receiver. You can enter the address or select from the global list shown when you click the button LIST on a terminal with keyboard or on the MAIL button on a terminal with touch screen.

Subject

Enter the subject for the message. Max 50 characters. The text in the message can be max 10 rows a 50 characters.

Terminal Controller

Used for RUN/TRANSFER switching via TCP/IP. Press **Edit** and enter the number of the port to be stated to enable transfer. The port number doesn't normally need to be changed. Mark Request authentication if username and password must be stated before transfer.



WWW Server

With this function you can configure the WWW-server in the terminal. A Web server is a program that, using the client/server model and the World Wide Web's Hypertext Transfer Protocol (HTTP), serves the files from Web pages to Web users (whose computers contain HTTP clients that forward their request). See the chapter *Network functions in the terminal*.

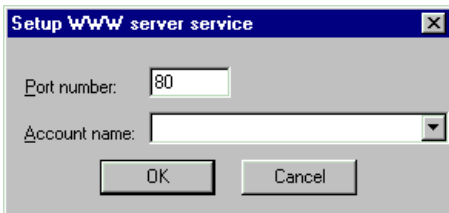

Port number

Default is 80 and should not be changed.

Account name

By selecting an account name you protect the HTML pages with password. Accounts are defined under **Network.. Accounts** in the **Setup** menu.

Account name

Shows the Account name entered in previous dialog.

Password

Enter a password. All HTML pages are protected with this Account name/password.

To protect a singel page with another Account name/Password you enter the following in the head of the HTML page.

```
<HTML>
<HEAD>
<META name="superuser" content="12345"*
</HEAD>
```

Here you place the rest of the HTML code.

```
</HTML>
```

* "superuser" is user name and "12345" is password.

Note!

The code above must be found in the header. The parameters Name and Content must correspond to an Account name and a Password.

18.5 Network accounts

Accounts define who may connect to services available at terminals requiring logon. The function is used to create access control. You create a name and password for different users who will have access to different network services.



19 Network functions in the terminal

The chapter is not valid for E50.

This chapter describes how the functions FTP server, SMTP client, applet and WWW server works in the terminal. For settings in the functions respective we refer to the chapter *Network communication*.

19.1 FTP server

FTP (File Transport Protocol), a standard Internet protocol, is the simplest way to exchange files between computers on the Internet. FTP is an application protocol that uses the Internet's TCP/IP protocols. FTP is commonly used to transfer Web page files from their creator to the computer that acts as their server for everyone on the Internet. It is also commonly used to download programs and other files to your computer from other servers.

Some directories shows files with the file length 0. This means that the file contain dynamic data i.e. the size of the file change. This means that the file is not empty even if the length is 0. The terminal don't use date on the files which means that the time shown is not relevant. The file name may not contain national characters.

The ROOT directory

In the root directory you will find the following directories ALARMS, HTML, RECIPE and TRENDS. Only the libraries that the user has access to is shown. You will also find the file info.txt containing information about the terminal here.

The file info.txt

The file contains information about the terminal according to the following example:

```
E700
Boot version: 4.01
Firmware version:V5.00
Build number: 124
Driver: FX-SERIES (CPU) V1.12.0
Dynamic memory: 304237 bytes free
Project memory: 184700 bytes free
```

Nothing can be deleted from the root directory, even if you have write access. If you delete the directories HTML or RECIPE the content of the directories are deleted but the directories are still there.

The ALARMS directory

The directory is only shown if there are any alarm defined in the terminal and the terminal is in run-time mode. The alarm groups are shown as SKV files with the length 0. This don't means that there aren't any alarms. The files can only be read. To read a file it must be opened with the attribute READ, READWRITE will cause error.

File format

Each alarm is stored in a row ending with <carriage return><linefeed>.

Syntax (E700 and bigger terminals)

```
status;activedate;activetime;inactivedate;inactivetime;ackdate;acktime;alarmtext
```

All fields are always there. If the alarm isn't acknowledged the fields for date and time are empty.

Syntax (other terminals)

```
status;activedatue;activetime;alarmtext
```

End the file with <carriage return><line feed>

The HTML directory

The data files handled by the Web server are stored here. You can create subdirectories. The start file is always named index.htm.

File format

The file format is depending on the type of file. We use standardized file format such as HTML e.t.c.

The RECIPE directory

The different recipes are shown as SKV files with the length 0 which don't mean that the recipe is empty. You can both read and write files in this directory. But you may not create a directory.

File format

Each recipe value are stored in a row ending with <carriage return><linefeed>.

Syntax

device;value;datatype:length

The file is ending with

END<carriage return><linefeed>

If the data type is array (AR) one value is shown on each line. The first line will be shown as above. The following lines will only contain

;value

The TRENDS directory

The directory is only available if there are trends defined in the terminal and the terminal is in run-time mode. The trend files are shown as SKV files with the length 0. The files can only be read. To read a file it must be opened with the attribute READ, READWRITE will cause error. Curve 1 in a trend must be used, otherwise the trend isn't valid.

File format

Each sampling are stored in a row ending with <carriage return><linefeed>.

Syntax

date;time;value1;value2;value3;value4;value5;value6;OFF

End the file with

END<carriage return><linefeed>

Only used curves in the trend are transferred, i.e. no empty fields.

OFF is in the sample in the following cases and indicates a pause in the sampling.

- When the terminal enter run-time mode. A copy of the latest stored sample is added. The copy has OFF indication. As soon as valid values reach the terminal new values without OFF indication are stored.
- When the signal Trend-enable is used. If the signal is reset a sample is indicated with OFF. When the signal is set a new value is stored without OFF indication.
- When you transfer stored trend values via FTP or HMI tools a sample will be stored with OFF indication. When the transfer is ready a new value is stored without OFF indication.

19.2 SMTP client

SMTP (Simple Mail Transfer Protocol) is a TCP/IP protocol used for sending and receiving email. However, since it is limited in its ability to queue messages at the receiving end, it is usually used with one of two other protocols, POP3 or IMAP, that let the user save messages in a server mailbox and download them periodically from the server. In other words, users typically use a program that uses SMTP for sending email and either POP3 or IMAP for receiving messages that have been received for them at their local server.

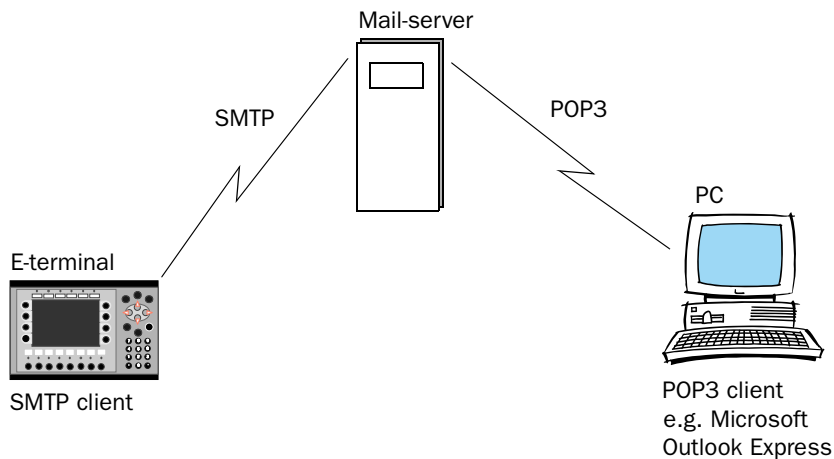

19.3 Terminal reflection – applet

An applet is a little application program. On the World Wide Webb, using Java, the object oriented programming language, an applet is a small program that can be sent along with a Web page to a user. Java applets can perform interactive animations, immediate calculations, or other simple tasks without having to send a user request back to the server.

From a PC it is possible to reflect the terminal in a browser, e.g. Microsoft Internet Explorer or Netscape Navigator. This is done by an application program presenting a picture of the terminal on the screen. The picture is updated at continuous time interval according to stated request. It is possible to affect by clicking with the mouse on the buttons in the terminal picture or using the keyboard. On a touch screen terminal you click directly on the screen.

The Applet-application is a cab-file in the terminal file system, in the HTML directory, and is transferred to the terminal via FTP. The file is unpacked when the Webb page it is linked to is activated, see the following example. The communication with the terminal is done with the function Terminal control (port 6001 predefined). The port number can be configured in the source code for the Web page via an parameter in the applet application. It is also possible to change the background color behind the terminal picture on the Web page. You connect to the WWW server in the terminal by entering the IP-address in the browser. When the Webb page is loaded you will find a terminal symbol with the text Terminal Interaction. The applet-application starts when you click on the symbol. Now a login dialog is shown. If the login is defined for the function Terminal control entered user parameters are verified with the users defined under Accounts. Otherwise you don't need to state anything in this dialog.

Example

```
<applet
  code=TERMAPPL.class
  name=TERMAPPL
  width=120
  height=60
  <PARAMNAME=CABBASE
  VALUE="E700APPL.CAB">
  <param name=TermCtrlPort value="6001">
  <param name=Background value=" ">
</applet>
```

19.4 Web server

A Web server is a program that, using the client/server model and the World Wide Web's Hypertext Transfer Protocol (HTTP), serves the files form Web pages to Web users (whose computers contain HTTP clients that forward their requests). Every computer (terminal) on the Internet that contains a Web site must have a Web server program.

SSI-script (server-side include)

A server-side include is a variable value (for examples a file) that a server can include in an HTML file before it is send to the requestor. If you create a Web page, you can insert an include statement in the HTML file that looks like this:

```
<!--#echo var="LAST_MODIFIED"-->
```

To show values from the terminal on Web pages we support the following SSI script.

Name	Parameters	Description	Example
get_ipaddr.fn	None	Shows the IP address for the Web server. Used in CGI script	<!--#exec cgi="get_ipaddr.fn"-->
get_domainname.fn	None	Shows the Web server domain-name	<!--#exec cgi="get_domainname.fn"-->
get_date.fn	Date format e.g. MM/DD/YY YY-MM-DD If no format is state the terminal setting is used	Shows the date in the terminal	<!--#exec cgi="/get_date.fn MM/DD/YY"-->

Name	Parameters	Description	Example
get_time.fn	Time format e.g. HH:MM:SS HH:MM If no format is state the terminal setting is used	Shows the time in the terminal	<!--#exec cgi="/get_time.fn HH:MM"-->
get_device.fn	X, Y, Z X=device Y=presentation format (see separate table) Z=length	Shows the device value from the PLC-system.	<!--#exec cgi="/get_device.fn D5"--> <!--#exec cgi="/get_device.fn D5LH"--> <!--#exec cgi="/get_device.fn M7"--> <!--#exec cgi="/get_device.fn D9ST,30"--> <!--#exec cgi="/get_device.fn D0AR,10"-->
get_diag.fn	None	Shows the diagnostic page of the terminal	<!--#exec cgi="/get_diag.fn"-->
get_mode.fn	None	Shows the mode of the terminal: RUN/PROG/SETUP/TRANSFER	<!--#exec cgi="/get_mode.fn"-->

Presentation format for get_device.fn

Name	Length	Description	Example
None	None	Shows the value as signed 16-bit	<!--#exec cgi="/get_device.fn D1"-->
+	None	Shows the value as unsigned 16-bit	<!--#exec cgi="/get_device.fn D3+"-->
L	None	Shows the value as signed 32-bit	<!--#exec cgi="/get_device.fn D7L"-->

Name	Length	Description	Example
L+	None	Shows the value as unsigned 32-bit	<!--#exec cgi=/get_device.fn D2L+-->
RB	None	Shows the value as 32-bit float BCD (MELSEC, SIMATIC)	<!--#exec cgi=/get_device.fn D10RB-->
RF	None	Shows the value as 32-bit IEEE float	<!--#exec cgi=/get_device.fn D8RF-->
RD	None	Shows the value as 32-bit IEEE float without exponent	<!--#exec cgi=/get_device.fn D1RD-->
SB	None	Shows the value as 16-bit BCD	<!--#exec cgi=/get_device.fn D3SB-->
LB	None	Shows the value as 32-bit BCD	<!--#exec cgi=/get_device.fn D7LB-->
SH	None	Shows the value as 16-bit HEX	<!--#exec cgi=/get_device.fn D2SH-->
LH	None	Shows the value as 32-bit HEX	<!--#exec cgi=/get_device.fn D1LH-->
AR	Number of values to be shown	Shows the value as signed 16-bit	<!--#exec cgi=/get_device.fn D5AR,10-->
ST	Number of characters in the string	Shows a number of registers as string	<!--#exec cgi=/get_device.fn D9ST,30-->

Automatic updating

Normally the Web page is not automatically updated. But by adding the following you create automatic updating.

```
<META HTTP-EQUIV="Refresh" CONTENT="5" >
```

CONTENT states how often the page will be updated (in seconds).

Example of a Web page with SSI script

```

<HTML>
<HEAD>
<META HTTP-EQUIV="Refresh" CONTENT="1">
</HEAD>

<!--#exec cgi="/get_ipaddr.fn"--><BR>
<!--#exec cgi="/get_domainname.fn"--><BR>
<BR>
Some IO:<BR>
<!--#exec cgi="/get_date.fn MM/DD/YY"--><BR>
<!--#exec cgi="/get_time.fn HH:MM"--><BR>
D5 = <!--#exec cgi="/get_device.fn D5"--><BR>
M7=<!--#exec cgi="/get_device.fn M7"--><BR>
D9 (string) = <!--#exec cgi="/get_device.fn D9ST,30"--><BR>
D0-D9 = <!--#exec cgi="/get_device.fn D0AR, 10"--><BR>
D8013 = <!--#exec cgi="/get_device.fn D8013"--><BR>

</HTML>

```

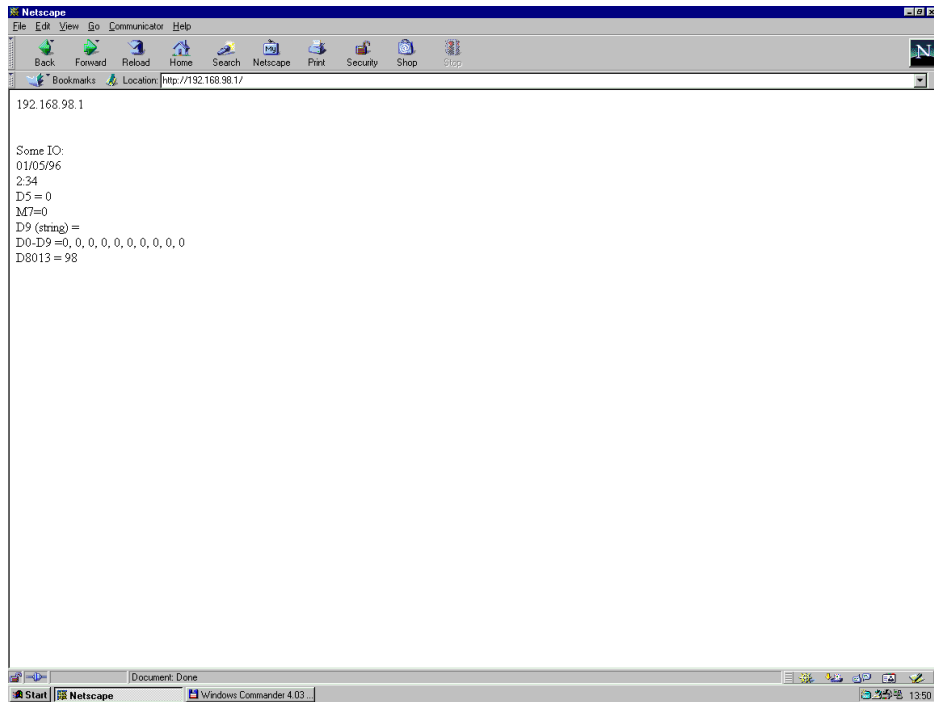

CGI script (common gateway interface)

The common gateway interface (CGI) is a standard way for a Web server to pass a Web user's request to an application program and to receive data back and forward to the user. When the user requests a Web page (for example, by clicking on a highlighted word or entering a Web site address), the server sends back the requested page. When a user fills out a form on a Web page and send it in, it usually needs to be processed by an application program. The Web server typically passes the form information to a small application program that processes the data and may send back a confirmation message. This method for passing data back and forth between the server and the application is called the common gateway interface (CGI). It is part of the Web's HTTP protocol.

To change values in the terminal we support the following CGI script:

Name	Parameters	Description	Example
set_date.fn	Date format e.g. MM/DD/ YY YY-MM-DD If no format is state the terminal setting is used	Used together with FORM to set the date in the terminal.	<pre><FORM ACTION="http://<!-- #exec cgi="/get_ipaddr.fn"->/ set_date.fn" METHOD="POST"> <INPUT SIZE=10 MAXLENGTH=10 NAME="YY:MM:DD"> <INPUT TYPE="submit" VALUE="Submit"> </FORM></pre>
set_time.fn	Time format e.g. HH:MM:SS HH:MM If no format is state the terminal setting is used	Used together with FORM to set the time in the terminal.	<pre><FORM ACTION="http://<!-- #exec cgi="/get_ipaddr.fn"->/ set_time.fn" METHOD="POST"> <INPUT SIZE=10 MAXLENGTH=10 NAME="HH:MM:SS"> <INPUT TYPE="submit" VALUE="Submit"> </FORM></pre>

Name	Parameters	Description	Example
set_device.fn	XY X = device Y = presentation format (see separate table) e.g. D0L+ D5SH	Used together with FORM to set an device in the PLC system.	<pre> <FORM ACTION="http://<!-- #exec cgi="/get_ipaddr.fn"->/ set_device.fn" METHOD="POST"> <INPUT SIZE=10 MAXLENGTH=10 NAME="DOL"> <INPUT TYPE="submit" VALUE="Submit"> </FORM> </pre>
set_mode.fn	RUN PROG SETUP TRANSFER	Used together with FORM to set the terminal mode.	<pre> <FORM ACTION="http://<!-- #exec cgi="/get_ipaddr.fn"->/ set_mode.fn" METHOD="POST"> <SELECT NAME="MODE"> <OPTION VALUE="RUN">Run <OPTION VALUE="PROG">Prog <OPTION VALUE="SETUP">Setup <OPTION VALUE="TRANSFER">Transfer </SELECT> <INPUT TYPE="submit" VALUE="Submit"> </FORM> </pre>

Name	Parameters	Description	Example
push_key.fn	(see separate table)	Used to simulate pressing a a on the terminal.	<pre> <FORM ACTION="http://<!-- #exec cgi="/get_ipaddr.fn"->/ push_key.fn" METHOD="POST"> <SELECT NAME="F2"> <OPTION VALUE="SET">Set <OPTION VALUE="RESET">Reset <OPTION VALUE="TOGGLE">Toggle </SELECT> <INPUT TYPE="submit" VALUE="Submit"> </FORM> <FORM ACTION="http://<!-- #exec cgi="/get_ipaddr.fn"->/ push_key.fn" METHOD="POST"> <INPUT SIZE=1 MAXLENGTH=1 NAME="Key"> <INPUT TYPE="submit" VALUE="Submit"> </FORM> </pre>

Presentation format for set_device.fn

Name	Description
None	Sets the value as signed 16-bit
+	Sets the value as unsigned 16-bit
L	Sets the value as signed 32-bit
L+	Sets the value as unsigned 32-bit
RB	Sets the value as 32-bit float BCD (MELSEC, SIMATIC)
RF	Sets the value as 32-bit IEEE float
RD	Sets the value as 32-bit IEEE float without exponent
SB	Sets the value as 16-bit BCD
LB	Sets the value as 32-bit BCD
SH	Sets the value as 16-bit HEX
LH	Sets the value as 32-bit HEX
ST	Sets a number of registers as a string

Parameters for push_key.fn

Parameter	Description	Example
KEY	Can state the values: A-Z 0-9 ACK LIST MAIN PREV BACKSPACE ENTER UP DOWN LEFT RIGHT	<pre><FORM ACTION="http://<!--#exec cgi="/ get_ipaddr.fn"-->/push_key.fn" METHOD="POST"> Key = <SELECT NAME="Key"> <OPTION VALUE="ENTER">Enter <OPTION VALUE="A">A <OPTION VALUE="B">B <OPTION VALUE="1">1 <OPTION VALUE="2">2 <OPTION VALUE="3">3 <OPTION VALUE="UP">Up <OPTION VALUE="DOWN">Down <OPTION VALUE="LEFT">Left <OPTION VALUE="RIGHT">Right <OPTION VALUE="PREV">Prev </SELECT> <INPUT TYPE="submit" VALUE="Submit"> <P> </FORM></pre>
F1-F22	Can state the values: SET RESET TOGGLE	<pre><FORM ACTION="http://<!--#exec cgi="/ get_ipaddr.fn"-->/push_key.fn" METHOD="POST"> <SELECT NAME="F2"> <OPTION VALUE="SET">Set <OPTION VALUE="RESET">Reset <OPTION VALUE="TOGGLE">Toggle </SELECT> <INPUT TYPE="submit" VALUE="Submit"> </FORM></pre>

Example on a Web page with SSI and CGI script:

```
<HTML>
<FORM ACTION="http://<!--#exec cgi="/get_ipaddr.fn"-->/
set_date.fn" METHOD="POST">
Set date here (YY:MM:DD):
<INPUT SIZE=10
    MAXLENGTH=10
    NAME="YY:MM:DD"
    VALUE="<!--#exec cgi="/get_date.fn"-->">
<INPUT TYPE="submit" VALUE="Submit"> <P>
</FORM>
<FORM ACTION="http://<!--#exec cgi="/get_ipaddr.fn"-->/
set_time.fn" METHOD="POST">
Set time here (HH:MM:SS):
<INPUT SIZE=10
    MAXLENGTH=10
    NAME="HH:MM:SS"
    VALUE="<!--#exec cgi="/get_time.fn"-->">
<INPUT TYPE="submit" VALUE="Submit"> <P>
</FORM>
<FORM ACTION="http://<!--#exec cgi="/get_ipaddr.fn"-->/
set_device.fn" METHOD="POST">
D0 =
<INPUT SIZE=10
    MAXLENGTH=10
    NAME="D0"
    VALUE="<!--#exec cgi="/get_device.fn D0"-->">
<INPUT TYPE="submit" VALUE="Submit">
</FORM>
</HTML>
```

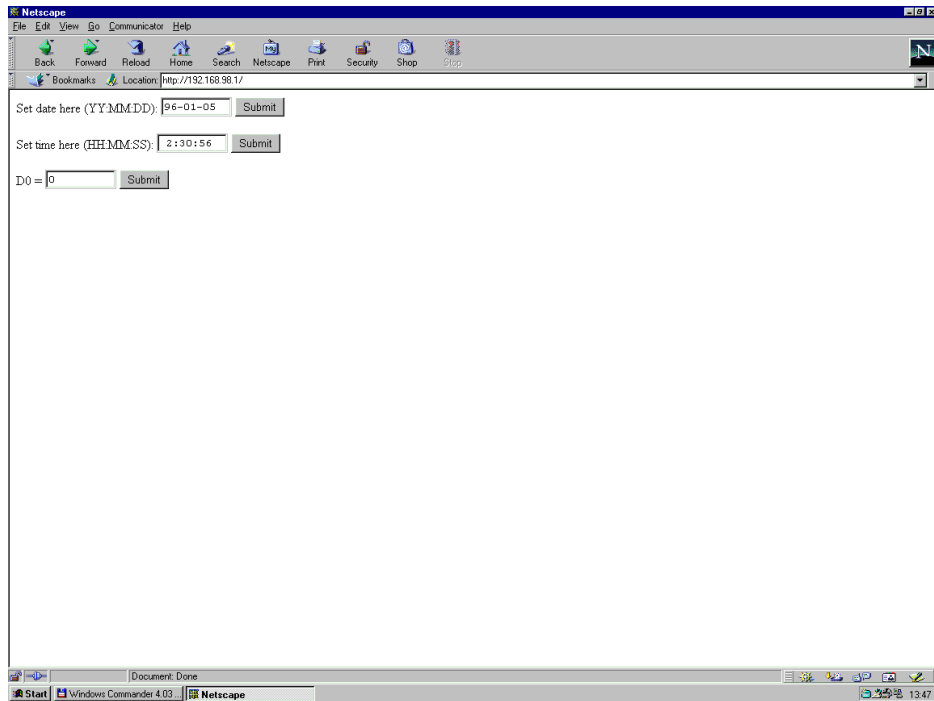

Save HTML files with FTP

To save HTML files in the terminal you use a standard FTP client software (see the section FTP server).

The files are stored in the HTML directory in the terminal.

The name of the files must be in DOS 8.3 format i.e. the name can contain max 8 characters and the extension must be HTM.

Note!

The file INDEX.HTM must be available.

19.5 Recommendations and limitations for network communication

To make the communication between terminals and controller systems in a terminal network (BDTP network) quick and efficient it is important to optimize the transfer of signals in the network. Read the chapter “Efficient communication” on page 26 and follow the rules described to optimize the network functionality in the terminals. Maximum number of signals that can be transferred in a terminal network are 3000.

Example

A terminal network consist of three clients and one server. Each client have access to 1000 signals which means that the server provide the clients with 3000 signals. This is valid even if the address areas for the signals in each client are in accordance with each other. Accordingly it is not possible to transfer further signals in this terminal network.

Transparent mode

To be able to make the function Transparent mode (see also the chapter Communication) work in a terminal network with communication via the TCP/IP protocol the following demands must be carried out.

- The driver and its programming tool must support communication in Transparent mode. For information we refer to the manuals for the driver and controller system respective and also the chapter Communication in this manual.
- The PC program COM/IP from Tactical Software which is available on the Web address http://www.tactical-sw.com/Products/CIM_IP/com_ip.html must be used in the PC communicating with the controller system in Transparent mode via the TCP/IP network.

The programming tools MELSEC MEDOC and MELSEC MEDOC *plus* for PLC systems from Mitsubishi Electric supports Transparent mode communication in TCP/IP network with MELSEC PLC systems according to the following table.

Programming tool	PLC system
MELSEC MEDOC	All MELSEC PLC-system except QnA-CPU and QnA-C24
MELSEC MEDOC <i>plus</i>	MELSEC A C24, MELSEC FX-series

No protocol mode

The function No protocol mode (see the chapter Communication), when the terminal is used as communication interface, is not recommended to be used in major terminal networks (BDTP networks). A major BDTP network is a network where many signals are transferred between server and clients. When the terminal is used as communication interface control registers and control signals are transferred and they affect the communication time and the performance of the network. See also the chapter “Efficient communication” on page 26.

Packing of signals

To make the communication between terminals and controller systems in a terminal network (BDTP network) quick and efficient it is important to optimize the transfer of signals in the network. Read the chapter “Efficient communication” on page 26 and follow the rules described to optimize the network functionality in the terminals. This is valid for all stations in a terminal network. If you don’t use packing of signals the time between updates of stations in the network will increase.

Alarm handling

The terminal network is a Client/Server network. Servers provide data, for example alarm signals, to Clients. Many different signals affects the communication time between terminals and controller systems in the network, this means that it is expedient to limit the number of signals affecting the communication. For more information see the chapter “Efficient communication” on page 26. The number of alarm signals in the network can not exceed what one server can handle in the network. One server can handle between 100 to 300 alarms, depending on application and terminal, consequently can the network not contain more than 100 to 300 alarms.

20 LEDs

The chapter is not valid for E50 and E100.

The terminal has LEDs built in, that are connected to registers defined under LED in the **Functions** menu. The content of the register determines the color and any blinking of the LED according to the following table.

Register value(Hex)	Register value(Dec)	Blinking frequency(Hz)	Color
00	0	-	None
01	1	-	Green
02	2	-	Red
11	17	5	Green
12	18	5	Red
21	33	2.5	Green
22	34	2.5	Red
31	49	1.2	Green
32	50	1.2	Red
41	65	0.6	Green
42	66	0.6	Red

21 Function keys

This section describes how to use the function keys. A function key is linked to a signal by writing in its address after each key or by selecting a function from the choice list. The signal linked to a function key is activated according to the function linked to the key when it was defined.

Note!

It is only possible to affect two signals linked to function keys at the same time. I.e. if more than two function keys are pressed at the same time it is only the two pressed first that are affected.

The terminal has different numbers of function keys depending on the type of terminal.

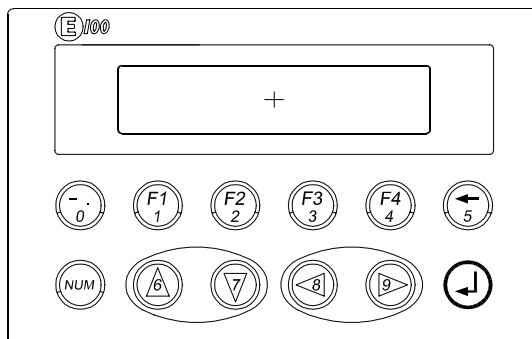
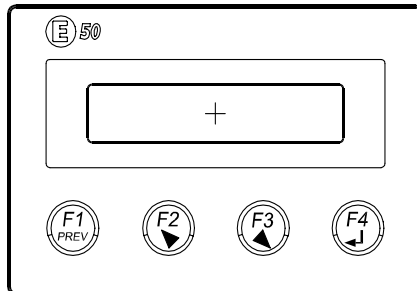

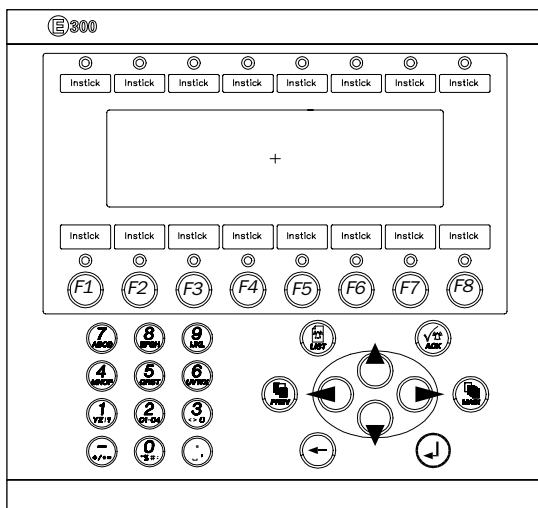
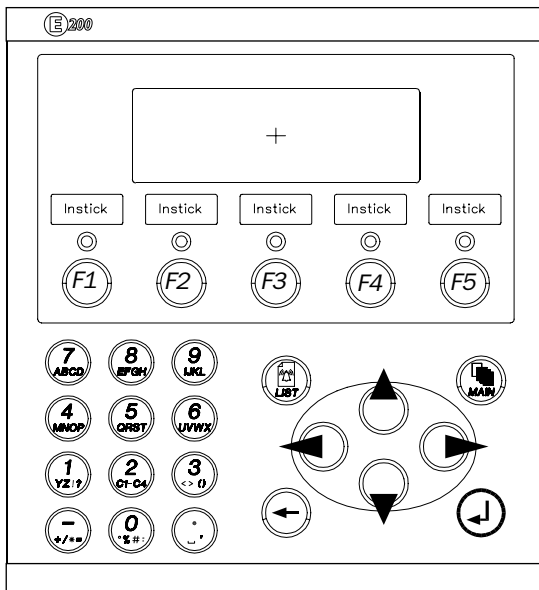

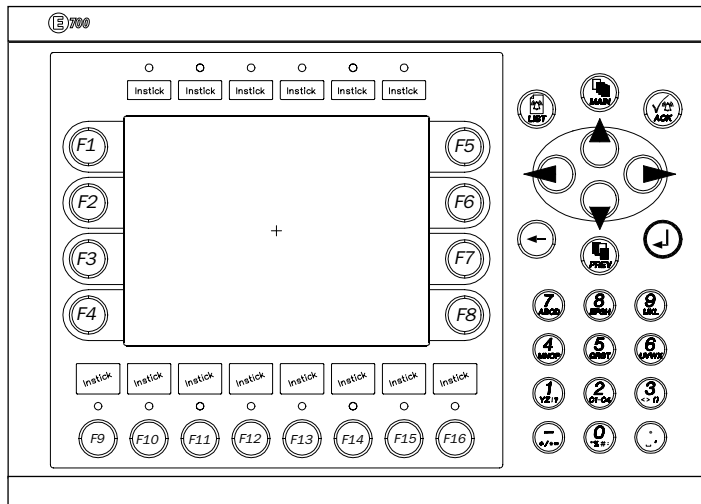
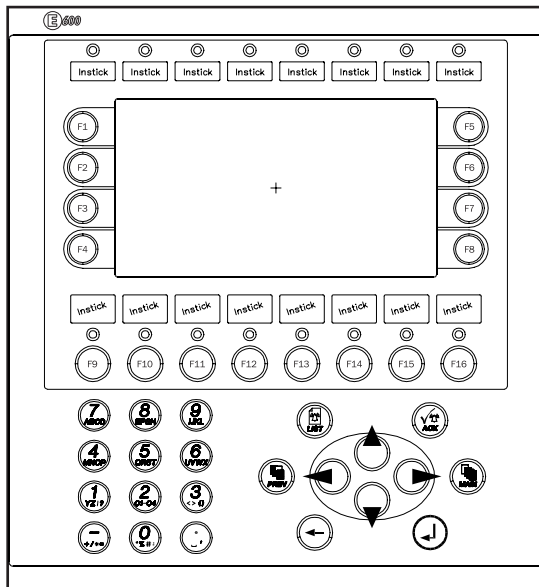

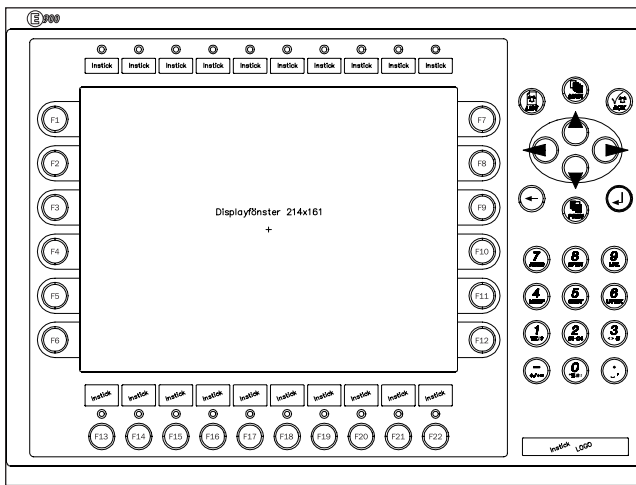
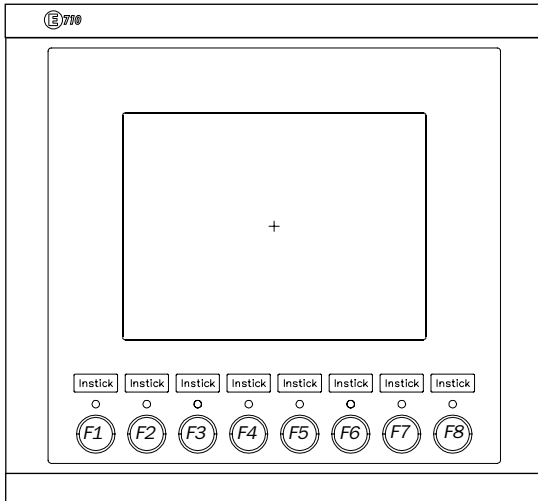

21.1 Definitions

There are two ways of defining the function keys; *globally* or *locally*. Global function keys are defined and used in the whole application, that is they apply in all the blocks. Local function keys are defined and used in a single block. A global definition is always available in the run-time mode assuming that the block shown on the display does not have a local definition for the function key in question. Local definitions have a higher priority than global ones. Global function keys are defined under **Function keys** in the **Functions** menu. Local function keys are defined in the blockheader of current block under F-keys.

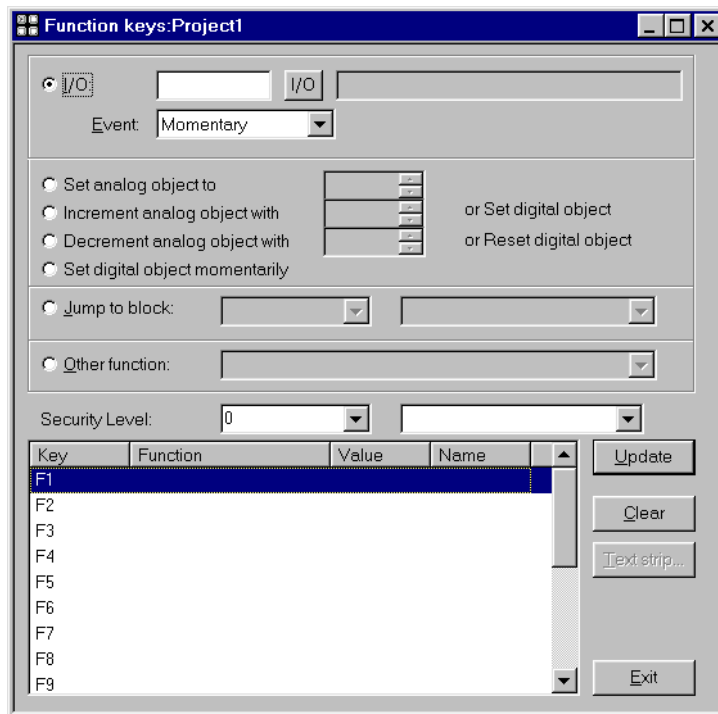

Function	Description
IO	The signal activated with the function key.
Event	<p>How the key affect the current digital signal.</p> <p>Momentary means that the signal is set as long as the key is active.</p> <p>Toggle means that the signal is set and reset respectively when the key is activated.</p> <p>Set means that the signal is set when the key is activated and remain set.</p> <p>Reset means that the signal is reset when the key is activated and remain reset.</p> <p>Grouped means that all signals linked to a function key with current group number is reset. The group number is entered under Value. A group can contain max 8 function keys.</p> <p>Set Analog means that the analog signal linked to the function key gets the value entered under Value.</p> <p>Inc Analog means that the analog signal linked to the function key shall increase the value with the value entered under Value.</p> <p>Dec Analog means that the analog signal linked to the function key shall decrease the value with the value entered under Value.</p>
Set analog object to	Sets selected analog object to entered value.
Increment analog object with or set digital object	Increases the value of an maneuverable analog object with entered value or sets a selected digital object.
Decrement analog object with or reset digital object	Decreases the value of an maneuverable analog object with entered value or sets a selected digital object.
Set digital object momentarily	Sets selected digital object as long as the key is pressed.
Jump to block	Jumps to the block with number nnn.
Security level	Function keys can be defined with a security level. The security level means that the operator must log in with a password for the same or a higher security level to be able to use the function key.
Fxx	The function key linked to one of the functions.

Other functions for Function keys

Function	Description
Load recipe	Load recipe from the memory of the terminal.
Save recipe	Save recipe into the memory of the terminal.
Delete recipe	Erase recipe from the memory of the terminal.
Login to specified security level	Logging in.
Logout	Logging out.
Change login password	Change password.
Scroll one page up	Scrolling the pages in text blocks and in the alarm list.
Scroll one page down	Scrolling the pages in text blocks and in the alarm list.
Zoom up text size	Increase the text size in the alarm list.
Zoom down text size	Reduce the text size in the alarm list.
Save recipe on memory card	Save recipe on the memory card defined as backup.
Load recipe from memory card	Load recipe from the memory card defined as backup.
Erase recipe on memory card	Erase recipe from the memory card defined as backup.
Save project on memory card	Save project on the memory card defined as backup.
Load project from memory card	Load project from the memory card defined as backup.
Erase project on memory card	Erase project from the memory card defined as backup.
Acknowledge alarm	Acknowledges alarms in the alarm list.
Show alarm list	Shows the alarm list (block 990).
Jump to info block connected to the alarm	Jump to a block connected to the alarm. See the chapter <i>Alarm handling</i> .
List alarm groups	Select from which alarm group alarms will be shown in the alarm list. Not valid in E100 and E200.
Return to previous block	Show the previous block, works for nine levels. When returning to block 0 you can't jump to the previous block using this function. If login in run-time is done on a higher security level than current level this function can't be used for block jump.

Function	Description
Show info about analog object	Shows the min. and max. values for analog objects in the Textblock in the run-time mode.
Show diagnostics page	Shows the information page. See the chapter <i>Terminal functions</i> .

21.2 Jump to block with the function keys

This function makes it possible to use the function keys for jumping to blocks without using the Display signal. When the key is defined, locally or globally, you select Jump to block in the list of options. Changing block via function keys is the easiest way to change block. The method do not occupy any digital signal in the controller system.

22 Expansions card

The chapter is not valid for E50, E100 and E200.

In the terminals there is a possibility to connect different expansion cards to increase the communication possibilities.

22.1 IFC PBDP

With the expansion card IFC PBDP the terminal can be connected to and communicate as a slave with a Profibus network. For information about how to setup the card, see the manual for the product. For information about how to configure a Profibus network, see the manual for Profibus network.

22.2 IFC MC

With the expansion card IFC MC you can connect a PCMCIA memory card to the terminal. You can select to use the memory card to expand the project memory, use it as backup or for moving files between terminals. For further information we refer to the manual for IFC MC.

22.3 IFC 128E

IFC 128E is an expansion card for connection of external function keys or switches. Up to 128 external function keys/switches can be used. For further information see the manual for the product.

22.4 IFC ETTP and IFC ETCX

The expansion cards IFC ETTP and IFC ETCX are cards for network communication using TCP/IP via a twisted cable or coaxial cable. For further information, see the manual for IFC ETTP and IFC ETCX.

22.5 IFC PI

IFC PI is an expansion card which makes it possible to connect a printer with parallel connection to the terminal. The RS-232 port on the expansion card can not be used for external communication. For further information see the manual for IFC PI.

23 Project transfer

The project must be transferred from the PC to the terminal, in order to be used in the terminal.

Connect the PC with MAC Programmer+ to the terminal via the cables MAC-PROG/9-CAB or CAB6.

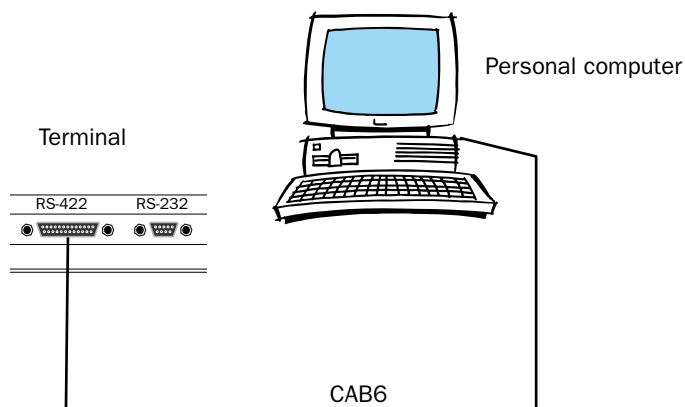
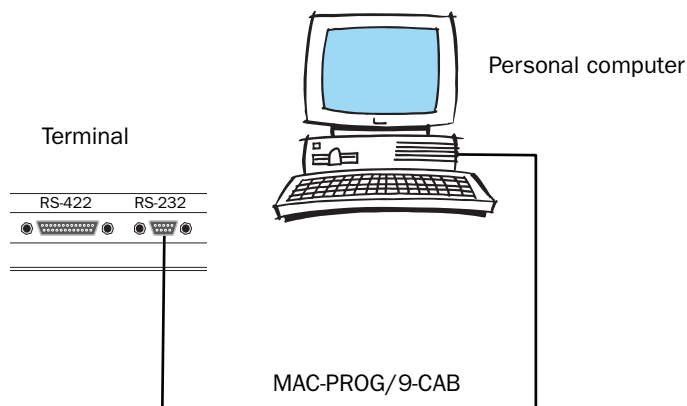

Note!

Driver and system program are also transferred when a project is transferred to E50. All communication between a PC and E50 is made via MAC Programmer+.

23.1 Terminal settings

The transfer parameters are set in the terminal in Setup mode under **Set-up, Port Parameters, MAC Programmer+**.

Note!

The communication settings must be the same in the PC software as in the terminal.

23.2 Transfer settings

The transfer is controlled from the MAC Programmer+. In the menu Project Transfer you can select what is to be transferred.

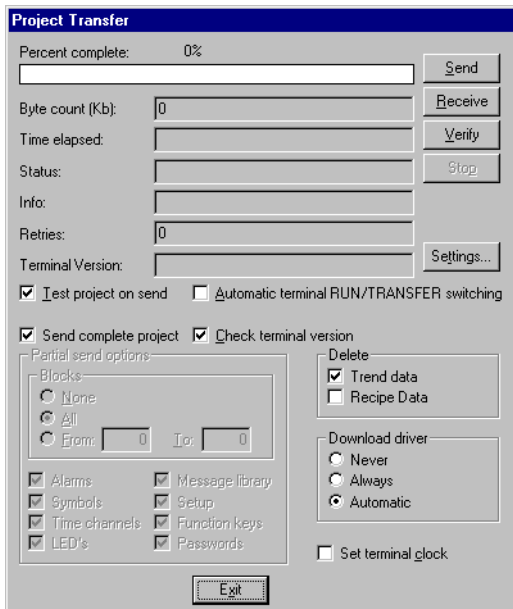

Parameter	Description
Percent complete	Shows the status of the transfer during transfer.
Byte count	Shows the number of bytes transferred during transfer.
Time elapsed	Shows elapsed time since one of the function's send, receive or verify was activated.
Status	Shows which part of the project that is transferred. For example Setup, block, alarm groups, symbols and function keys.
Info	Display the defined driver that will be send to the terminal.
Retries	When the transfer fails, the MAC Programmer+ makes a number of retries before the transfer is shut down.
Terminal version	When contact is enabled with the terminal, current terminal type and program version are displayed here.
Test project on send	Tests automatically the project before transfer.
Automatic terminal RUN/Transfer switching	The terminal is automatically put in transfer mode and will return to the previous mode after transfer.
Check terminal version	Checks the terminal version and gives a warning if the project and the terminal don't match.
Send complete project	Select if you want to transfer the whole project.
Partial send options	<p>None: No blocks are sent to the terminal.</p> <p>All: All blocks are sent to the terminal.</p> <p>From To: State an interval of blocks to be sent to the terminal.</p> <p>Alarms: Select if alarms shall be sent to the terminal.</p> <p>Symbols: Select if symbols shall be sent to the terminal.</p> <p>Time channels: Select if time channels shall be sent to the terminal.</p> <p>LED's: Select if LED's shall be sent to the terminal.</p> <p>Message library: Select if message library shall be sent to the terminal.</p> <p>Setup: Select if the setup shall be sent to the terminal.</p> <p>Function keys: Select if function keys shall be sent to the terminal.</p> <p>Passwords: Select if passwords shall be sent to the terminal.</p>
Delete	<p>Trend data: Delete all stored trend data in the terminal.</p> <p>Recipe data: Delete all stored recipe data in the terminal.</p>

Parameter	Description
Download driver	<p>Never: Driver will never be downloaded. Always: Driver will always be downloaded. Automatic: Driver will be downloaded to the terminal when the driver in the terminal and the driver defined in current project are not the same.</p> <p>These parameters are valid for both driver and system program for E50.</p>
Set terminal clock	The clock in the personal computer will be sent to the terminal.
Send	Transfer the project to the terminal according to current settings.
Receive	The MAC Programmer+ loads the project in the terminal. Current project in the MAC Programmer+ will be overwritten.
Verify	Compares the project in the MAC Programmer+ with the project in the terminal.
Stop	Interrupt the transfer.
Settings	Select if TCP/IP transfer or Serial transfer. If you select TCP/IP transfer no further settings is necessary. If you select Serial transfer the parameters described in the table below must be stated.

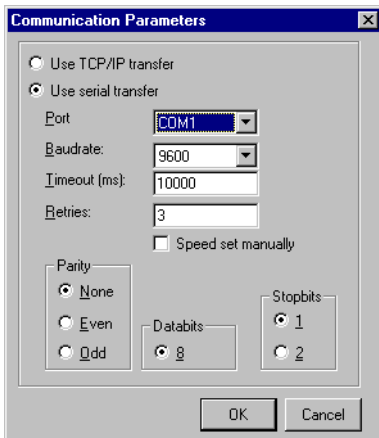

The communication parameters are set under **Comm Settings** in the **Transfer** menu or by choosing **Settings** in the **Project Transfer** dialog.

Parameter	Description
Use TCP/IP transfer	Select if the project shall be transferred via TCP/IP
Use serial transfer	Select this if you will use serial transfer of the project.
Port	Select communication port.
Baudrate	Baudrate (bits/second).
Timeout	Number of milliseconds between retries.
Retries	Number of retries before the transfer is shut down.
Parity	Select type of parity control.
Databits	Select number of data bits. Must be 8 bits.
Stopbits	Select number of stop bits.
Speed set manually	Used when communication via a modem. You must set the baudrate in the terminal and PC software manually and they must be the same.

Note!

Communication can fail if other programs are running under Windows at the same time as the transfer takes place. Failure is avoided by shutting down the other programs. During block transfer, links to relevant symbols are included. If the symbols are not transferred, problems may occur.

23.3 TCP/IP transfer

When transferring via TCP/IP you need to select **Use TCP/IP transfer** in the **Comm Settings** dialog in the **Transfer** menu. When you press **Send** in the **Project transfer dialog** the following dialog is shown.



The screenshot shows a dialog box titled "Sending Project1". It has three input fields: "Host address:" with the value "192.168.98.1", "Terminal control port:" with the value "6001", and "Transfer port:" with the value "6000". Below these is a section titled "Login information" which contains two input fields: "User ID:" and "Password:". There is also a checkbox labeled "Save password in project" which is currently unchecked. At the bottom of the dialog are two buttons: "OK" and "Cancel".

Host address

State the IP address of the terminal you want to transfer to.

Terminal Control port

State the TCP/IP-port number for RUN/TRANSFER switching. Need normally not to be changed. Default is 6001.

Transfer port

State the TCP/IP-port number for transferring. Need normally not to be changed. Default is 6000.

User ID

State a username used during RUN/Transfer switching authentication. Not needed if the terminal is already in transfer mode.

Password

State a password used during RUN/Transfer switching authentication. Not needed if the terminal is already in transfer mode.

Save password in project

Saves the password and user id so that you don't need to enter it next time.

23.4 Serial transfer

When serial transfer is used you need to select Use serial transfer in the Comm Settings dialog in the Transfer menu. When you press Send in the Project Transfer dialog the project will be sent to the terminal.

23.5 Transfer via modem

Settings when using modem communication between a PC and an operator terminal.

Modem settings

Make the settings on the modem connected to the operator terminal as follows:

```
AT &F E0 Q1 &D0 &K0 &W
```

Make the settings on the modem connected to the PC as follows:

```
AT &F &D0 &K0 &Q0 &W
```

The table below describes the modem commands.

Command	Description
AT	Inform the modem that a command follows. Each command shall be preceded by AT.
&F	Load the default settings
E0	Echo off
Q1	Command answer off
&D0	The modem ignore the DTR signal
&K0	No flow control
&Q0	Direct asynchronous mode
&W	Save settings

Communication at selectable speed

1. Configure the modem.
2. Make the communication settings in the **Comm settings** dialog under **Transfer** in MAC Programmer+.

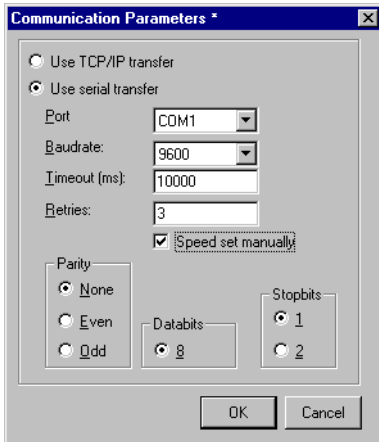

3. Set Baudrate, parity, data bits, stop bits and select Speed set manually.
4. Set the communication parameters in the terminal in the same way as in the MAC Programmer+ (Setup – Port parameters – MP)
5. Set the terminal in Transfer mode.
6. Use HMI Tools Modem program to make the call up.

7. Then you select **Transfer** in MAC Programmer+.

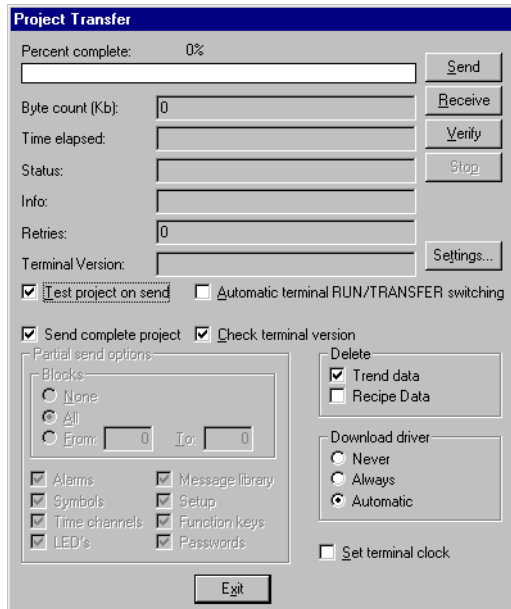

Don't select Automatic terminal RUN/TRANSFER switching.

Automatic transfer

1. Configure the modem.
2. Make the communication settings in the **Comm settings** dialog under **Transfer** in MAC Programmer+. The baudrate must be 2400 baud.

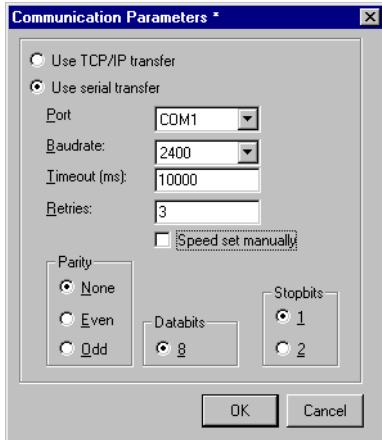

3. Use HMI Tools modem program to make the call up.

4. Then you select Transfer in MAC Programmer+.

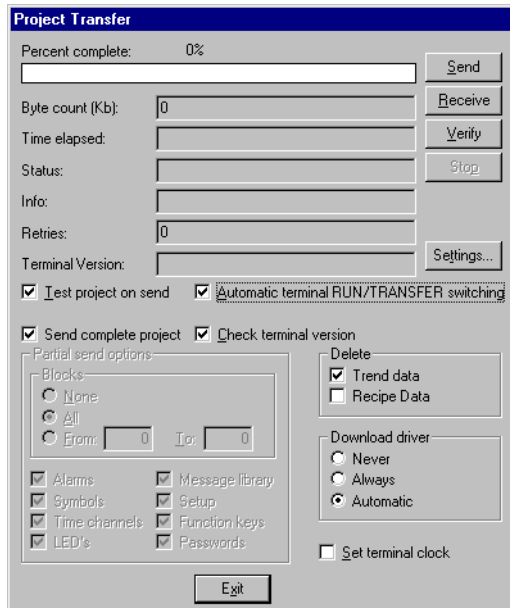

Note!

If Auto terminal RUN/TRANSFER switching is used the baudrate must be set to 2400 baud.

24 Technical data

E50

Parameter	Data
Front panel	Width 104 x Height 69 x Depth 4.5 mm.
Mounting depth	38 mm excl. D-sub and 38 mm incl. D-sub.
Front panel seal	IP 65, NEMA 4
Rear panel seal	IP 20
Keyboard material	Membrane keyboard with polyester snap discs. Overlay film of Autotex 2 F200 with print on reverse side. 1 million operations.
Reverse side material	Alu-Zink
Weight	Excl. D-sub: 0.2 kg.
Serial port RS-422	25-pin D-sub contact, chassis mounted female with standard locking screws 4-40 UNC.
Serial port RS-232	9-pin D-sub contact, chassis mounted male with standard locking screws 4-40 UNC, available when delivered adapter 232-25-AP is mounted on the RS422 port.
Contrast setting	Via potentiometer.
Display	LCD display (liquid crystal), 2 lines á 16 characters, 5 mm character height. Background light: lifetime 50000 h at the ambient temperature of +25°C.
Memory	Flash memory, 16 kb for application.
Real time clock	±10 PPM + error because of ambient temperature and supply voltage. Total max error 1 min/month= 12min/year. Minimum life: 10 years of the battery for the real time clock.
Supply voltage	+5 VDC from PLC or external. Battery eliminator connector 2.1 mm.
Current consumption at rated voltage	Max: 200 mA.
Ambient temperature	+0° to +50°C
Storage temperature	-20° to +70°C
Relative humidity	Max 85% non-condensing.
EMC tests on the terminal	G & L Beijer Electronics AB confirm that the terminal conforms with the essential protection requirements in article four of the directive 89/336/EEC. Noise tested according to: EN50081-1 emission and EN50082-2 immunity.

E100

Parameter	Data
Front panel	Width 142 x Height 90 x Depth 3.5 mm.
Mounting depth	28 mm excl. D-sub and 96.5 mm incl. D-sub.
Front panel seal	IP 65
Rear panel seal	IP 20
Keyboard material	Membrane keyboard with polyester snap discs. Overlay film of Autotex 2 F200 with print on reverse side. 1 million operations.
Reverse side material	Alu-Zink
Weight	Excl. D-sub: 0.5 kg.
Serial port RS-422	25-pin D-sub contact, chassis mounted female with standard locking screws 4-40 UNC.
Serial port RS-232	9-pin D-sub contact, chassis mounted male with standard locking screws 4-40 UNC.
Contrast setting	Using a potentiometer placed in the upper right corner at the rear of the terminal.
Display	LCD display (liquid crystal), 2 lines á 20 characters, 5 mm character height. Background light: lifetime 50000 h at the ambient temperature of +25°C.
Memory	Flash memory, 64 kb for application.
Real time clock	±10 PPM + error because of ambient temperature and supply voltage. Total max error 1 min/month= 12min/year. Minimum life: 10 years of the battery for the real time clock.
Supply voltage	+5 VDC from PLC or external. Battery eliminator connector 2.1 mm.
Current consumption at rated voltage	Max: 200 mA.
Ambient temperature	+0° to +50°C
Storage temperature	-20° to +70°C
Relative humidity	Max 85% non-condensing.
EMC tests on the terminal	G & L Beijer Electronics AB confirm that the terminal conforms with the essential protection requirements in article four of the directive 89/336/EEC. Noise tested according to: EN50081-1 emission and EN50082-2 immunity.

E200

Parameter	Data
Front panel	Width 147 x Height 163.5 x Depth 5 mm.
Mounting depth	38 mm excl. D-sub and 107 mm incl. D-sub.
Front panel seal	IP 65
Rear panel seal	IP 20
Keyboard material	Membrane keyboard with polyester snap discs. Overlay film of Autotex 2 F200 with print on reverse side. 1 million operations.
Reverse side material	Alu-Zink
Weight	Excl. D-sub: 0.7 kg.
Serial port RS-422	25-pin D-sub contact, chassis mounted female with standard locking screws 4-40 UNC.
Serial port RS-232	9-pin D-sub contact, chassis mounted male with standard locking screws 4-40 UNC.
Contrast setting	Using a potentiometer placed in the upper right corner at the rear of the terminal.
Display	LCD display (liquid crystal), 4 lines á 20 characters, 5 mm character height. Background light: lifetime 50000 h at the ambient temperature of +25°C.
Memory	Flash memory, 64 kb for application.
Real time clock	±10 PPM + error because of ambient temperature and supply voltage. Total max error 1 min/month= 12min/year. Minimum life: 10 years of the battery for the real time clock.
Supply voltage	+24 VDC (20-30 VDC), must conform with the requirements for SELV according to IEC 950 or IEC 742.
Current consumption at supply voltage +24 VDC	Max: 150 mA.
Fuse	1 AT, Littelfuse R452 001 (Nano ² SMF Slo-Blo). Placed at the rear under the cabinet near the 24 V-connector.
Ambient temperature	+0° to +50°C
Storage temperature	-20° to +70°C
Relative humidity	Max 85% non-condensing.
EMC tests on the terminal	G & L Beijer Electronics AB confirm that the terminal conforms with the essential protection requirements in article four of the directive 89/336/EEC. Noise tested according to: EN50081-1 emission and EN50082-2 immunity.

E300

Parameter	Data
Front panel	Width 211.5 x height 198 x depth 5.7 mm.
Mounting depth	69 mm excl. D-sub and 110 mm incl. D-sub.
Front panel seal	IP 65
Rear panel seal	IP20
Keyboard material	Membrane keyboard with polyester snap discs. Overlay film of Autoex 2 F200 with print on reverse side. 1 million operations.
Reverse side material	Yellow-chromated steel plate.
Weight	Excl. D-sub: 1.5 kg
Serial port RS-422	25-pin D-sub contact, chassis mounted female with standard locking screws 4-40 UNC.
Serial port RS-232	9-pin D-sub contact, chassis mounted female with standard locking screws 4-40 UNC.
Expansion slots	1 built-in expansion slot.
Display	LCD display (liquid crystal), 240x64 pixel, monochrome, 4 rows of 20 characters or 8 rows of 40 characters. Background light: life 50000 h at the ambient temperature of +25°C.
Memory	Flash memory, 128 kb for application.
Real time clock	±10 PPM + error because of ambient temperature and supply voltage. Total max error 1 min/month=12min/year. Minimum life: 10 years of the battery for the real time clock.
Supply voltage	+24 VDC (20-30 VDC), must conform with the requirements for SELV according to IEC 950 or IEC 742.
Current consumption at rated voltage	Max load: 300 mA
Fuse	1 AT, Littelfuse R452 001 (Nano ² SMF Slo-Blo). Placed at the rear under the cabinet near the 24 V-connector.
Ambient temperature	0° to 50°C
Storage temperature	-20° to +70°C
Relative humidity	Max 90% without condensation.
EMC tests on terminal	G & L Beijer Electronics AB confirm that the terminal conforms with the essential protection requirements in article four of the directive 89/336/EEC. Noise tested according to: EN50081-1 emission and EN50082-2 immunity.

E600

Parameter	Data
Front panel	Width 214 x height 232 x depth 5 mm.
Mounting depth	69 mm excl. D-sub and 110 mm incl. D-sub.
Front panel seal	IP 65
Rear panel seal	IP20
Keyboard material	Membrane keyboard with polyester snap discs. Overlay film of Autoex 2 F200 with print on reverse side. 1 million operations.
Reverse side material	Yellow-chromated steel plate.
Weight	Excl. D-sub: 1.4 kg
Serial port RS-422	25-pin D-sub contact, chassis mounted female with standard locking screws 4-40 UNC.
Serial port RS-232	9-pin D-sub contact, chassis mounted female with standard locking screws 4-40 UNC.
Expansion slots	1 built-in expansion slot.
Display	LCD display (liquid crystal), 240x128 pixel, monochrome, 16 rows of 40 characters. Background light: life 50000 h at the ambient temperature of +25°C.
Memory	Flash memory, 128 kb for application.
Real time clock	±10 PPM + error because of ambient temperature and supply voltage. Total max error 1 min/month=12min/year. Minimum life: 10 years of the battery for the real time clock.
Supply voltage	+24 VDC (20-30 VDC), must conform with the requirements for SELV according to IEC 950 or IEC 742.
Current consumption at rated voltage	Max load: 450 mA
Fuse	1 AT, Littelfuse R452 001 (Nano ² SMF Slo-Blo). Placed at the rear under the cabinet near the 24 V-connector.
Ambient temperature	0° to 50°C
Storage temperature	-20° to +70°C
Relative humidity	Max 85% without condensation.
EMC tests on terminal	G & L Beijer Electronics AB confirm that the terminal conforms with the essential protection requirements in article four of the directive 89/336/EEC. Noise tested according to: EN50081-1 emission and EN50082-2 immunity.

E700

Parameter	Data
Front panel	Width 276 x Height 198 x Depth 5.7 mm
Mounting depth	Excl. D-sub: 89 mm Incl. D-sub: 110 mm.
Front panel seal	IP 65
Rear panel seal	IP 20
Keyboard material	Membrane keyboard with polyester snap discs. Overlay film of Autotex 2 F200 with print on reverse side. 1 million operations.
Reverse side material	Yellow-cromated steel plate.
Weight	Excl. D-sub: 1.7 kg
Serial port RS-422	25-pin D-sub contact, chassis mounted female with standard locking screws 4-40 UNC.
Serial port RS-232	9-pin D-sub contact, chassis mounted male with standard locking screws 4-40 UNC.
Expansion slots	2 built-in expansion slots.
Display	LCD display (liquid crystal), 320x240 pixel, 16 colors, graphic and text. Background light: lifetime 10000 h at the ambient temperature of +25°C.
Memory	Flash memory, 400 kb.
Real time clock	±10 PPM + error because of ambient temperature and supply voltage. Total max error 1 min/month= 12min/year. Minimum life: 10 years of the battery for the real time clock.
Supply voltage	+24 VDC (20-30 VDC), must conform with the requirements for SELV according to IEC 950 or IEC 742.
Current consumption at rated voltage	Without load: 300 mA Max load with expansion card: 550 mA.
Fuse	1 AT, Littelfuse R452 001 (Nano ² SMF Slo-Blo). Placed at the rear under the cabinet near the 24 V-connector.
Ambient temperature	+5° to +40°C.
Storage temperature	-20° to +60°C.
Relative humidity	Max 85% non-condensing.
EMC tests on the terminal	G & L Beijer Electronics AB confirm that the terminal conforms with the essential protection requirements in article four of the directive 89/336/EEC. Noise tested according to: EN50081-1 emission and EN50082-2 immunity.

E710

Parameter	Data
Front panel	Width 211.5 x Height 198 x Depth 5.7 mm
Mounting depth	Excl. D-sub: 89 mm Incl. D-sub: 110 mm.
Front panel seal	IP 65
Rear panel seal	IP 20
Keyboard material	Membrane keyboard with polyester snap discs. Overlay film of Autotex 2 F200 with print on reverse side. 1 million operations.
Reverse side material	Yellow-cromated steel plate.
Weight	Excl. D-sub: 1.7 kg
Serial port RS-422	25-pin D-sub contact, chassis mounted female with standard locking screws 4-40 UNC.
Serial port RS-232	9-pin D-sub contact, chassis mounted male with standard locking screws 4-40 UNC.
Expansion slots	2 built-in expansion slots.
Display	LCD display (liquid crystal), 320x240 pixel, 16 colors, graphic and text. Background light: lifetime 10000 h at the ambient temperature of +25°C. Touch screen
Memory	Flash memory, 400 kb for application.
Real time clock	±10 PPM + error because of ambient temperature and supply voltage. Total max error 1 min/month= 12min/year. Minimum life: 10 years of the battery for the real time clock.
Supply voltage	+24 VDC (20-30 VDC).
Current consumption at rated voltage	Without load: 300 mA Max load with expansion card: 550 mA.
Fuse	1 AT, Littelfuse R452 001 (Nano ² SMF Slo-Blo). Placed at the rear under the cabinet near the 24 V-connector.
Ambient temperature	+5° to +40°C.
Storage temperature	-20° to +60°C.
Relative humidity	Max 85% non-condensing.
EMC tests on the terminal	G & L Beijer Electronics AB confirm that the terminal conforms with the essential protection requirements in article four of the directive 89/336/EEC. Noise tested according to: EN50081-1 emission and EN50082-2 immunity.

24.1 Membrane keyboard

Solvent resistance and enviromental data for Autotex 2

Autotex 2 withstands exposure of more than 24 hours duration under DIN 42 115 Part 2 to the following chemicals without visible change:

Ethanol	Formaldehyde 37%-42%	1.1.1. Trichloroethane (Genklene)
Cyclohexanol	Acetaldehyde	Ethylacetate
Diacetone alcohol	Aliphatic hydrocarbons	Diethyl ether
Glycol	Toluene	N-Butyl acetate
Isopropanol	Xylene	Amylacetate
Glycerine	White spirit	Butyccellosolve
Methanol	Formic acid <50%	Ether
Triacetin	Acetic acid <50%	Sodium hypchlorite <20% (Bleach)
Dowanol DRM/PM	Phosphoric acid <30%	Hydrogen peroxide <25%
Acetone	Hydrochloric acid <36%	Potassium carbonate
Metyl ethyl ketone	Nitric acid <10%	Washing powders
Dioxan	Trichloroacetic acid <50%	Fabric conditioner
Cyclohexanone	Sulphuric acid <10%	Ferric chloride
MIBK	Cutting oil	Ferrous chloride
Isophorone	Diesel oil	Dibutyl Phthalate
Ammonia <40%	Linseed oil	Diocetyl Phthalate
Caustic soda <40%	Paraffin oil	Sodium carbonate
Potassium hydroxide <30%	Blown castor oil	
Alkalicarbonate	Silicone oil	
Bichromate	Turpentine substitute	

Potassium ferrocyanide/ferricyanide	Universal brake fluid	
Acetonitrile	Decon	
Sodium bisulphate	Aviation fuel	
	Petrol	
	Teepol	
	Water	
	Sea water	

Autotex withstands DIN 42 115 Part 2 exposure of <1 hour duration to glacial acetic acid without visible change.

Autotex is **not** resistant to the following chemicals:

Concentrated mineral acids
Concentrated caustic solution
High pressure steam at over 100°C
Benzyl alcohol
Methylene chloride

Autotex withstands 24 hours exposure to the following reagents at 50°C without visible staining:

Top Job	Grape Juice	Ariel	Ajax
Jet Dry	Milk	Persil	Vim
Gumption	Coffee	Wisk	Domestos
Fantastic		Lenor	Vortex
Formula 409		Downey	Windex

Very slight discoloration was noted under critical viewing conditions with the following materials:

Tomato juice
Tomato ketchup
Lemon juice
Mustard

Environmental data

Minimum use temperature

Tactile embossed Autotex has been tested to 0.5 million switch operation at -40°C (-40°F) without loss of function.

Maximum use temperature

Low moderate humidity: 85°C

High humidity (>90% RH): 40°C

Outdoor use

In common with all polyester based films Autotex is not suitable for use in conditions of long term exposure to direct sunlight.

24.2 Drawings

E-series RS-232/RS422

RS-232
MAC 50/90/Exxx, MTA-250/G1/Exxx
MAC 10/CM, CM10

Pin no	Name	Signal direction MAC ↔ XXX
2	TxD	↑
3	RxD	↓
5	0V	
7	CTS	↓
8	RTS	↑
9*	+5V <5mA	↑

D-sub
9-pin Hona
9-pin Male

* Ej i E-serien
Not in E-series

RS-422
MAC 50/90, MTA-250/G1

Pin no	Name	Signal direction MAC ↔ XXX
2	+TxD	↑
1	-TxD	
4	+RxD	↓
3	-RxD	
6	+RTS	↑
5	-RTS	
10	+CTS	↓
9	-CTS	
8,15	0V	
13,14	+5V <20mA	↑

D-sub
15-pin Hona
15-pin Female

RS-422
MAC 40+/Exxx, MTA-100/Exxx
MAC 10/CM, CM10

Pin no	Name	Signal direction MAC ↔ XXX
2	+TxD	↑
15	-TxD	
3	+RxD	↓
16	-RxD	
4	+RTS	↑
17	-RTS	
5	+CTS	↓
18	-CTS	
20	1)	
21	1)	
7,8	0V	
14	2) +5V <50mA	↑
12,13	3) +5V >200mA	↓

D-sub
25-pin Hona
25-pin Female

- 1) Stift 20 är anslutet till stift 21 internt i MAC'en.
Pin no 20 connected to pin no 21 internal in MAC/MTA.
- 2) Endast i E-serien och med serie nr 9901 eller senare
Only for E-series and with serial no 9901 or later
- 3) Endast E100/MAC40+/MTA-100
Only for E100/MAC40+/MTA-100

BEIJERS
BEIJER ELECTRONICS

Drawn: BLE Date: 1993-09-07 Page: 1 of 1
Revision: 1993-12-01 Page: 1 of 1
Drawing No: S-00724

MAC/MTA RS-232/RS-422

232-25-ADP adapter to E50

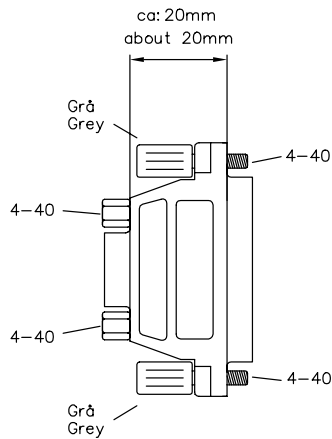

9pol D-sub Hane
9pin D-sub Male

25pol D-sub Hane
25pol D-sub Male

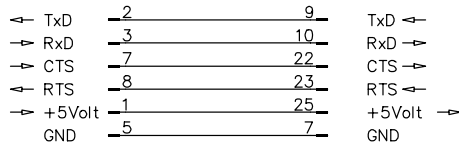

Drawn to scale 1:1

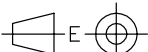

Ej angivna toleranser
enl. SMS 715 Medel

BEIJERS
BEIJER ELECTRONICS

232-25-ADP

Drawn	Date	App.	Revision	Revision date	Page	Next page	Drawing No.
LPN	1999-11-26		-	-	1	-	S-02860

E50 Outline

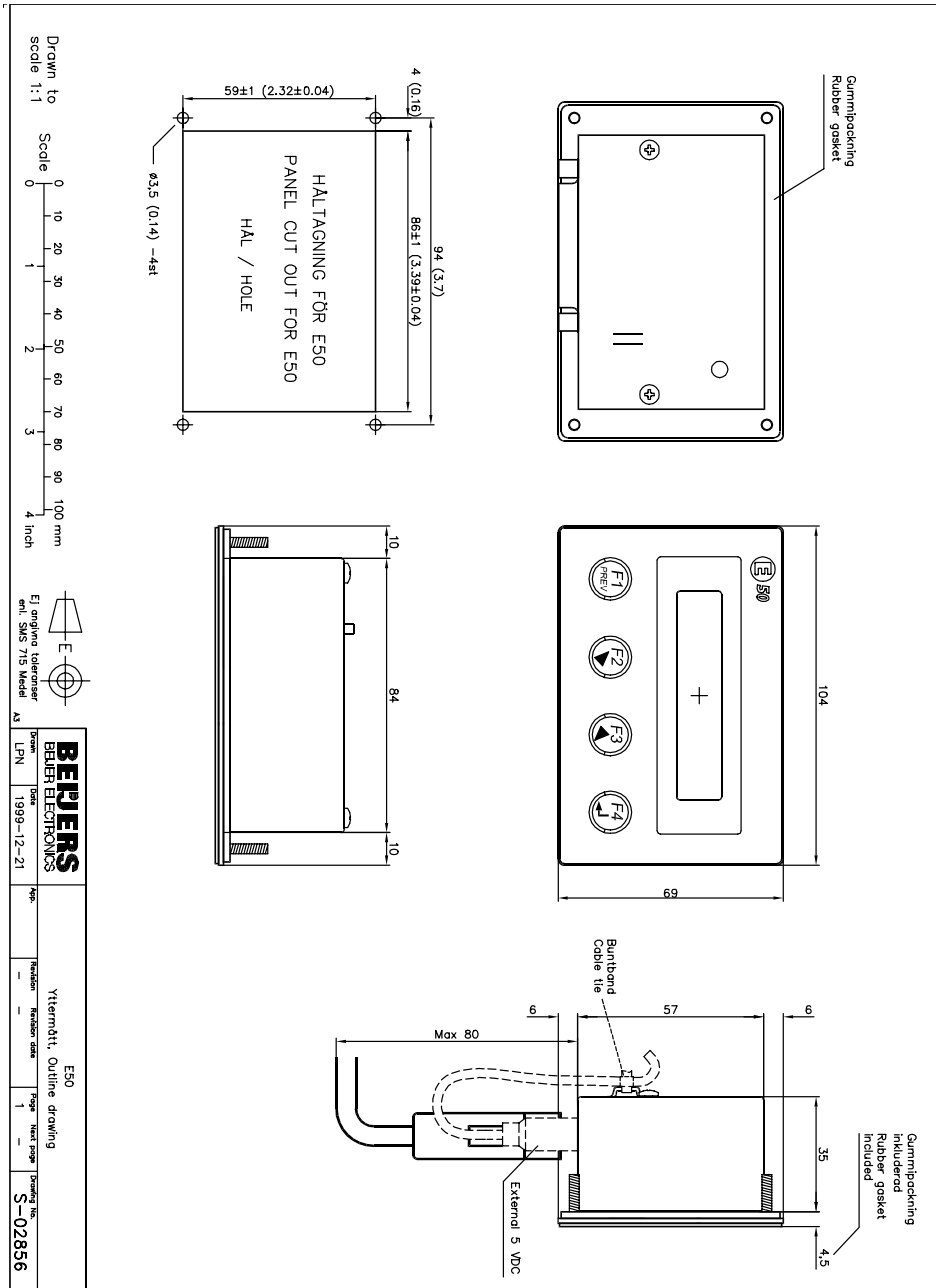

E100 Outline

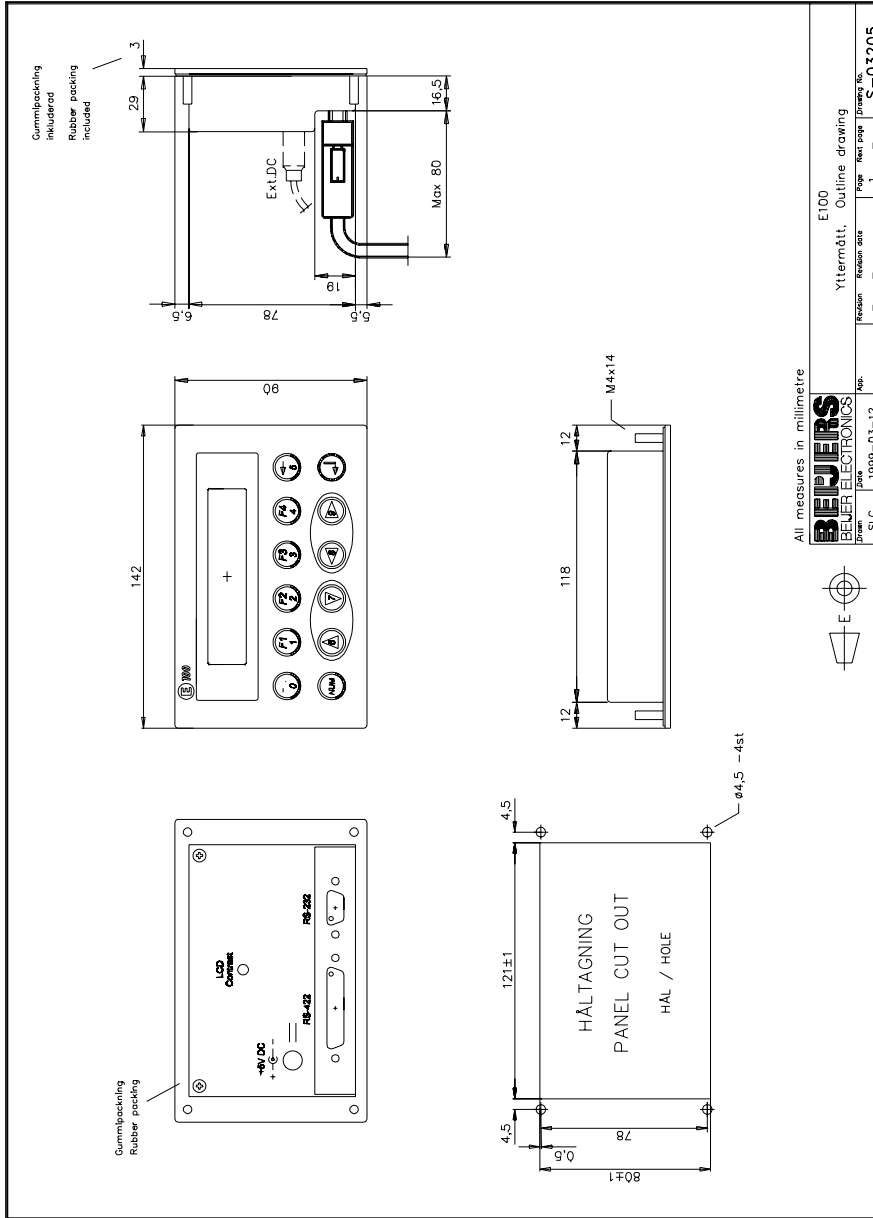

E200 Outline

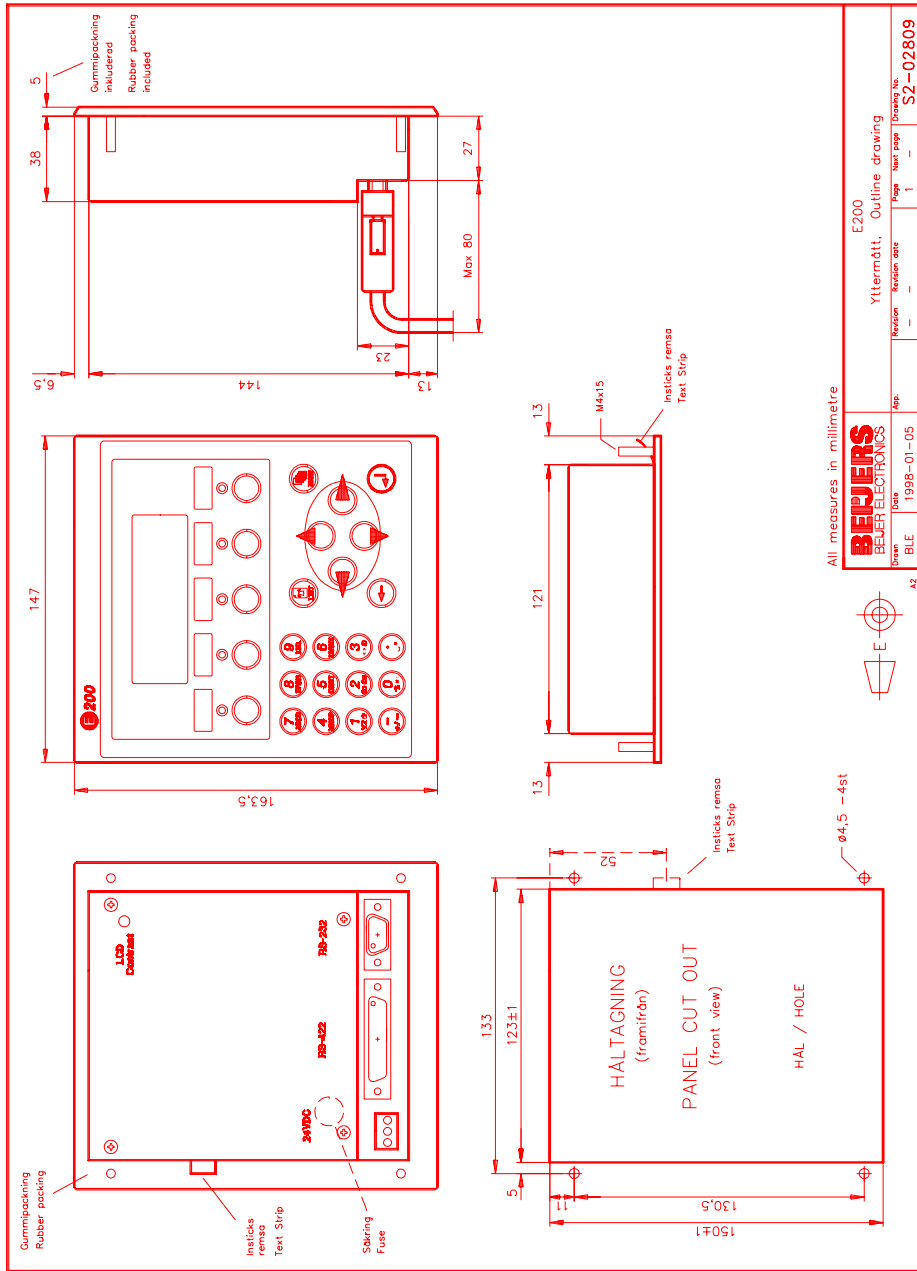

E200 Text strip

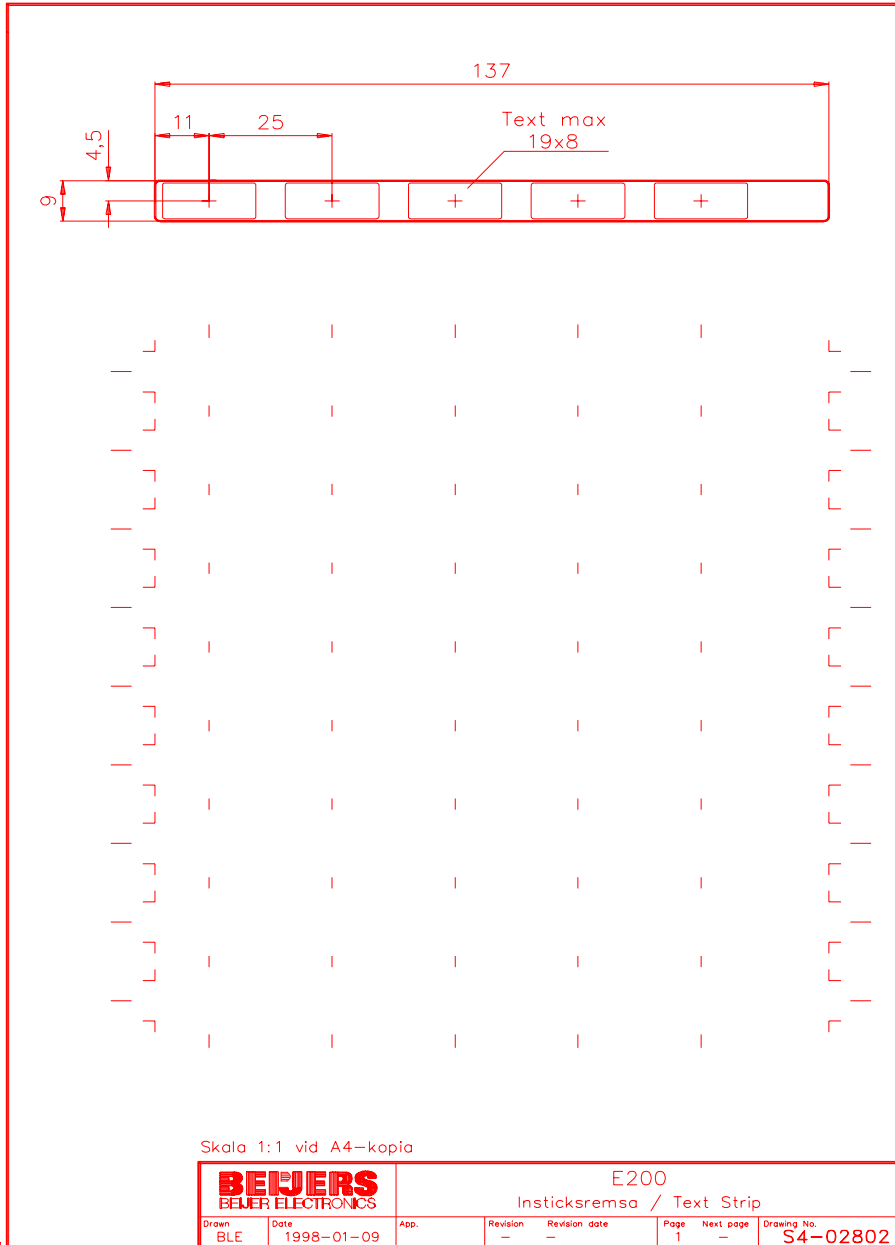

E300 Outline

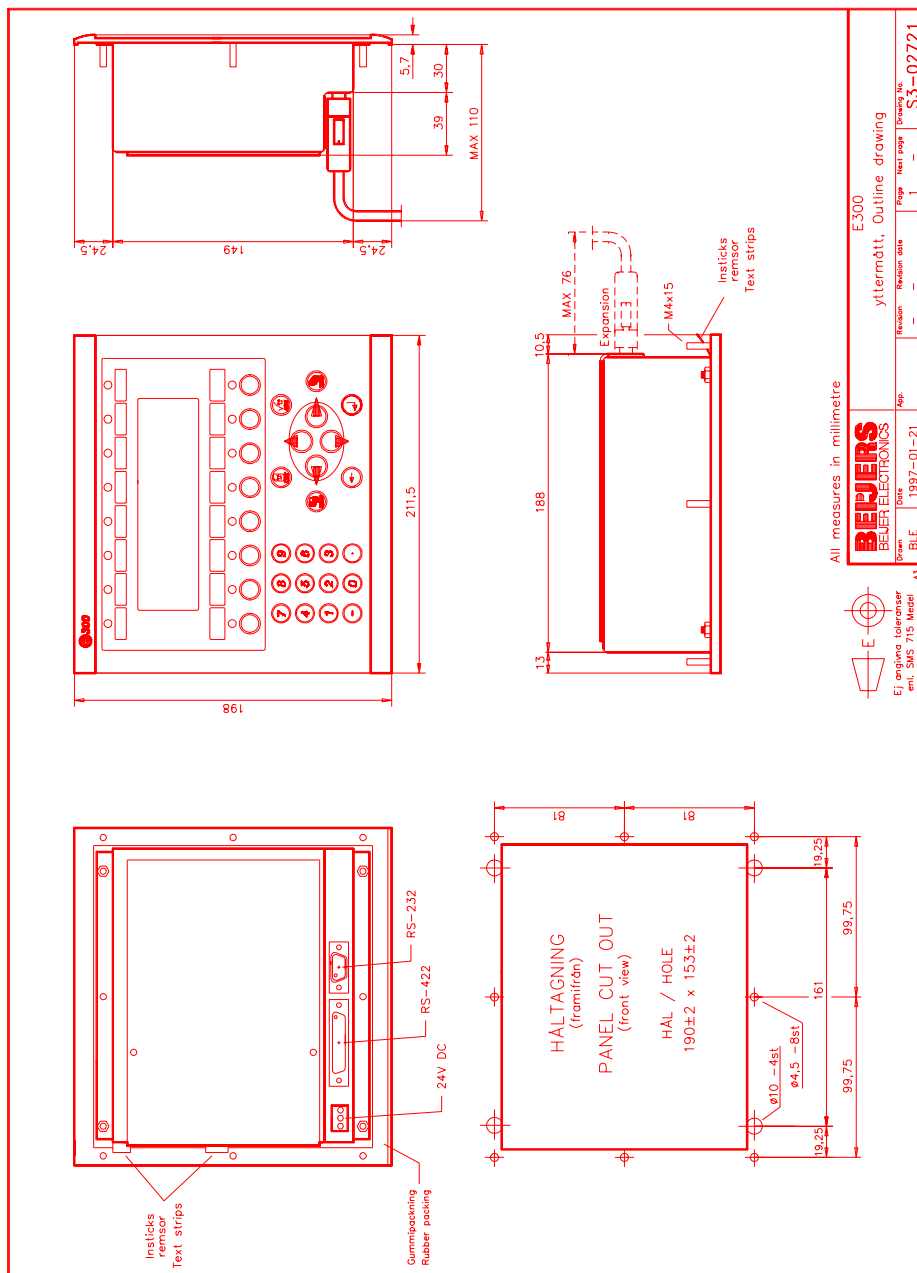

All measures in millimetre



EJ enginska tecken
ent. SMS 715 Metrikl

BEIPEPERS
BEIPEPERS ELECTRONICS

Drawn Date 1997-01-21 App. BLE

E300
ytlermått, Outline drawing

Revision Revision date Page Next page Drawing No.
1 1 S3-02721

E300 Text strip

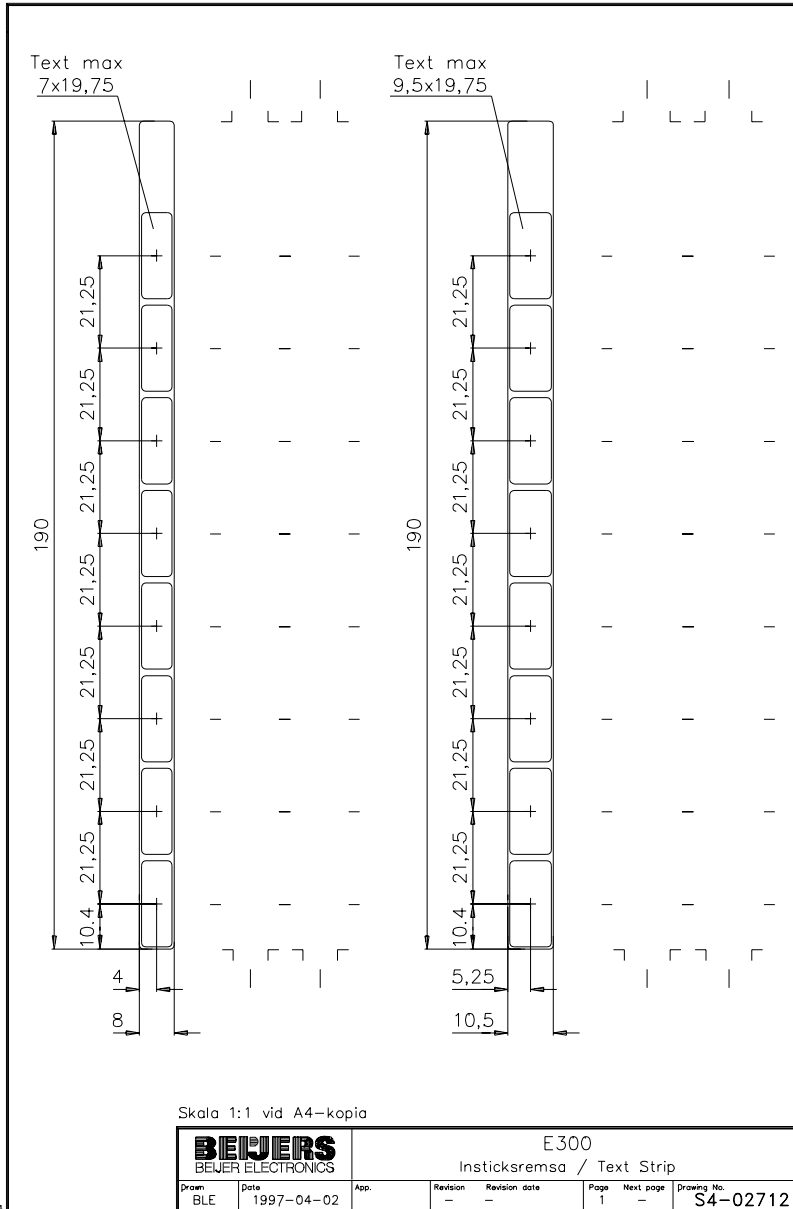

E600 Outline

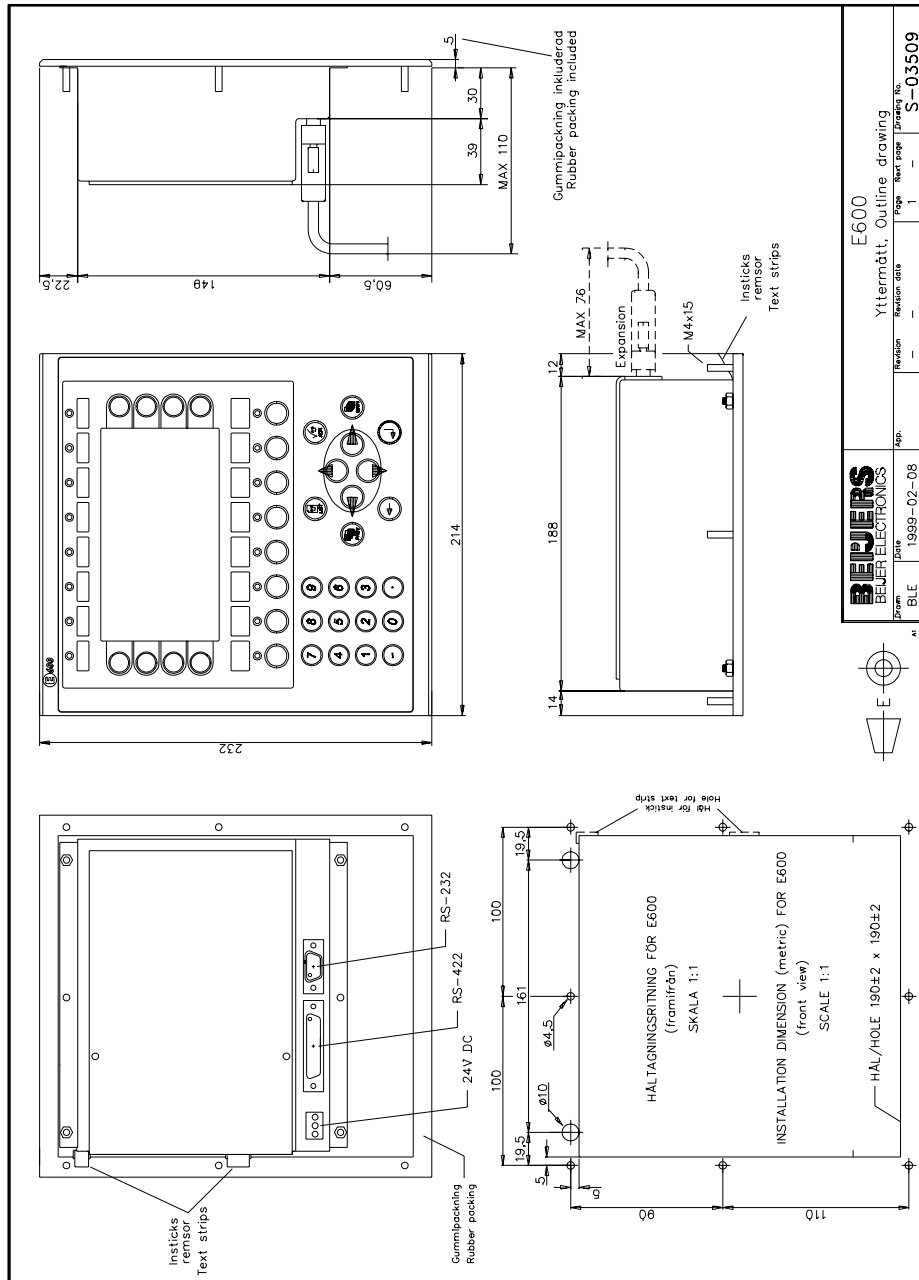

BEIJERS BEIJER ELECTRONICS		E600	
Yttermätt, Outline drawing	Revision	Page	Sheet No.
BLE	1999-02-08	1	S-03509

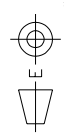

E600 Text strip

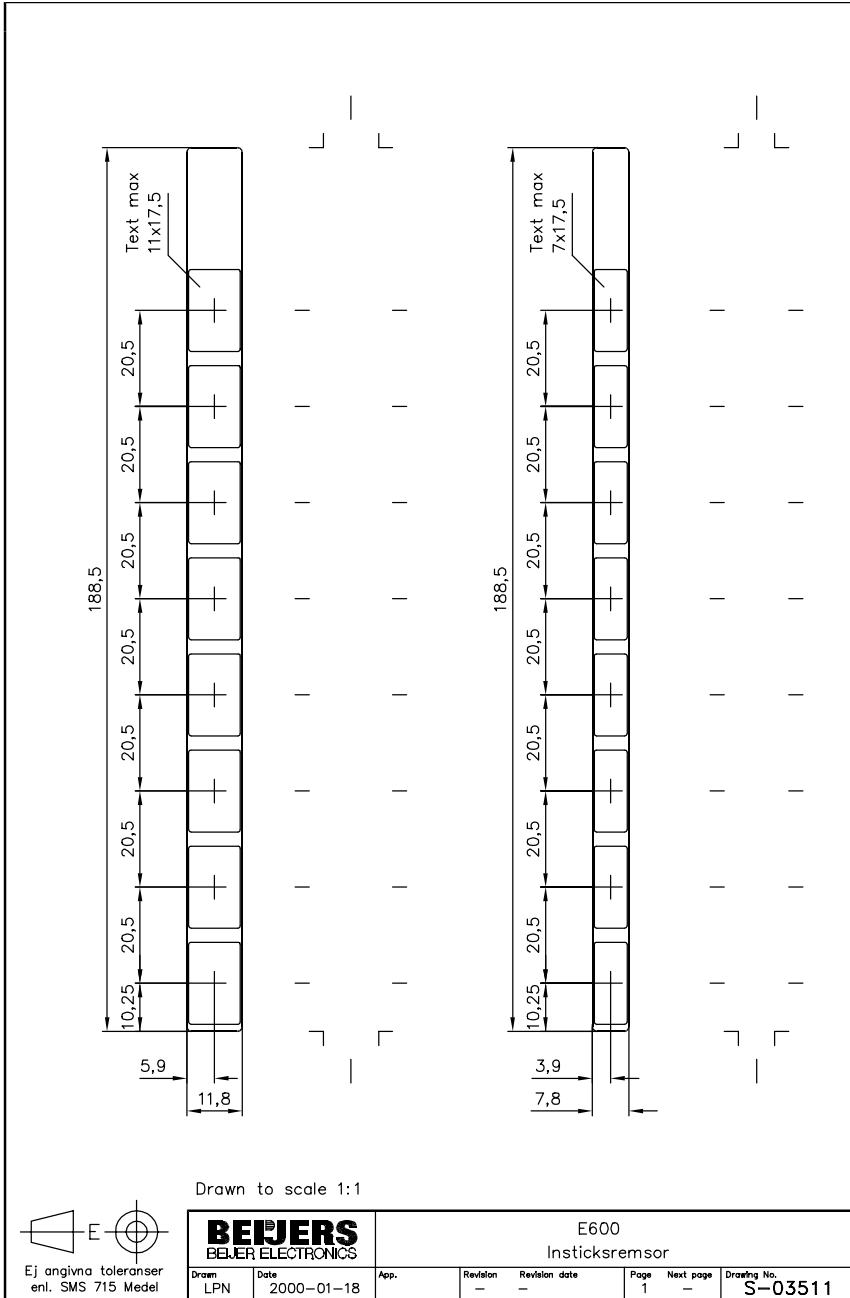

E700 Outline

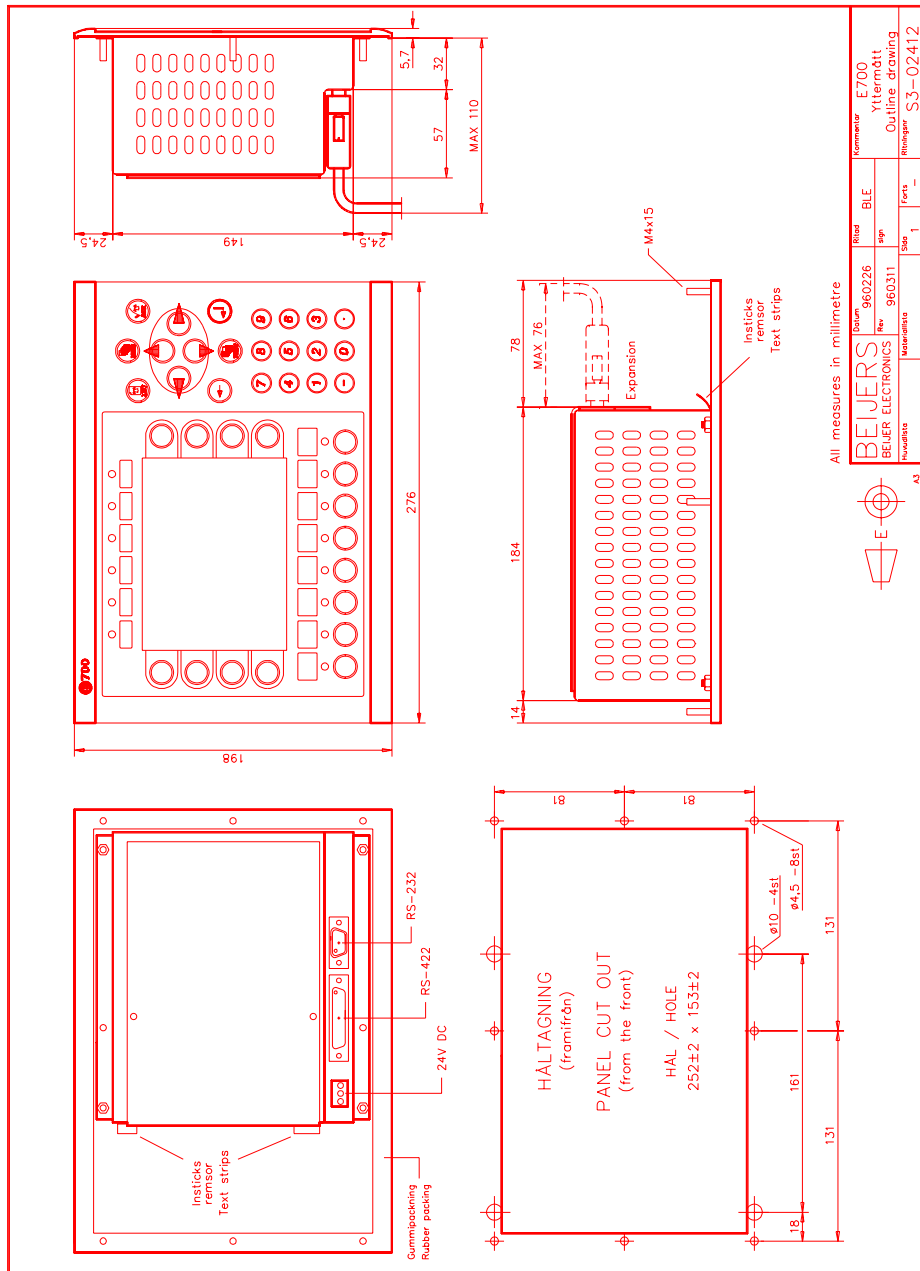

E700 Text strip

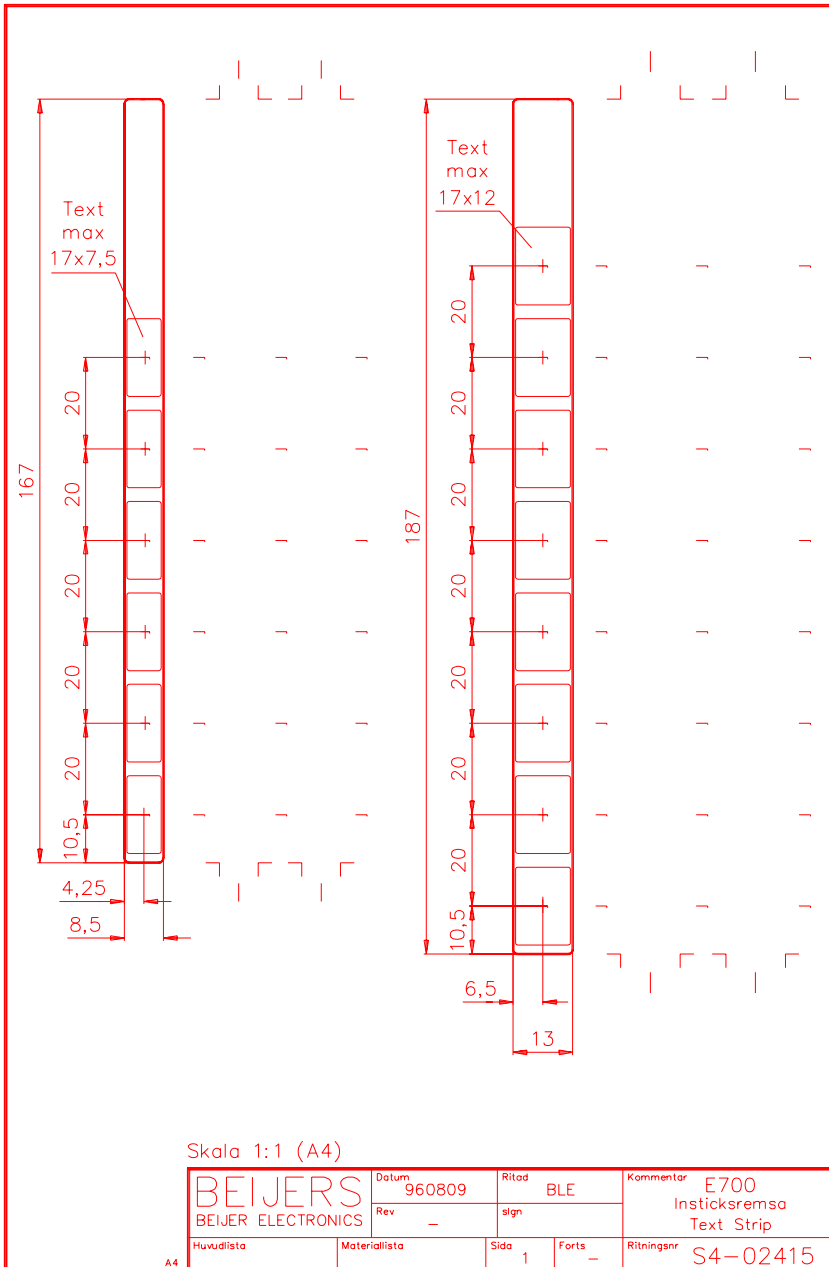

E710 Outline

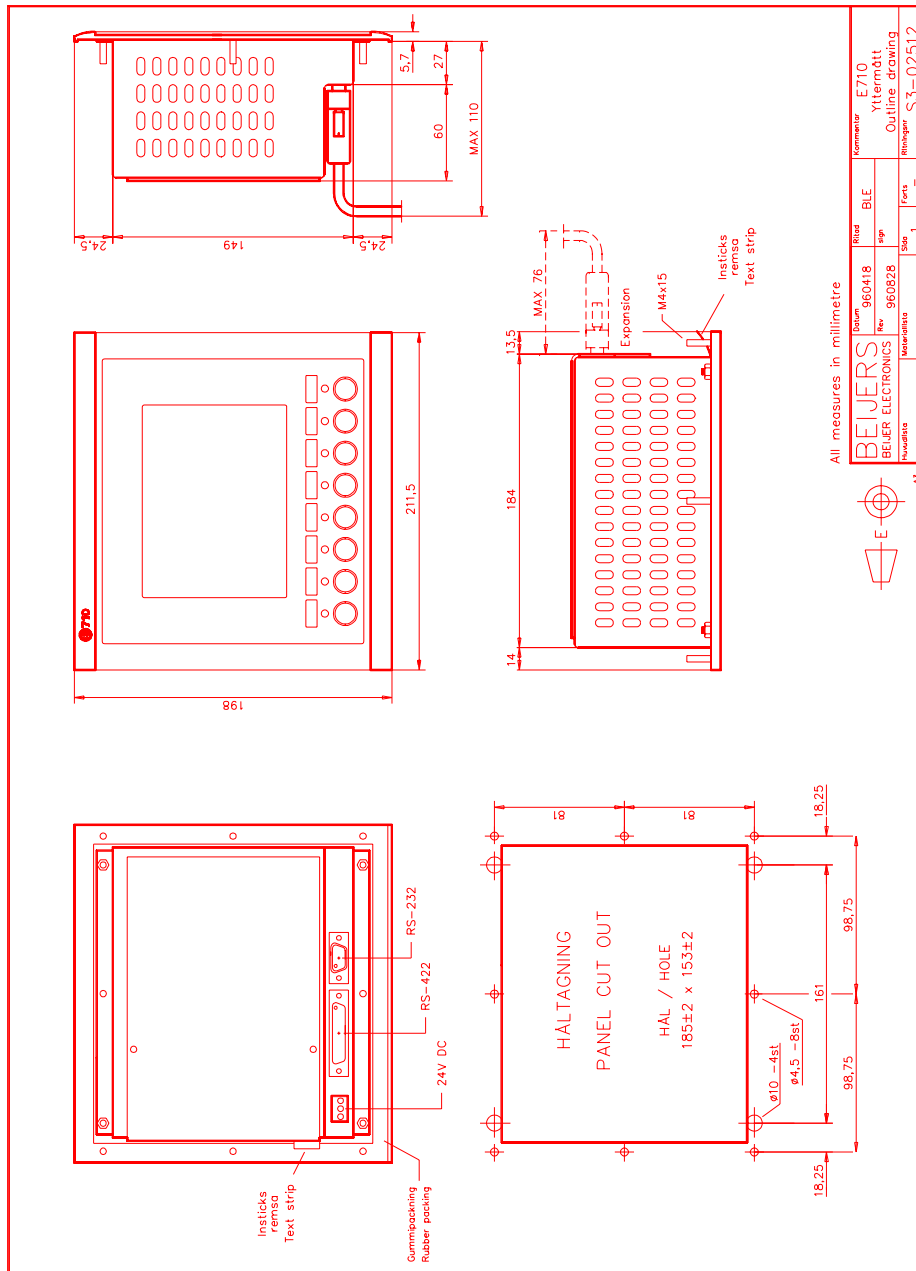

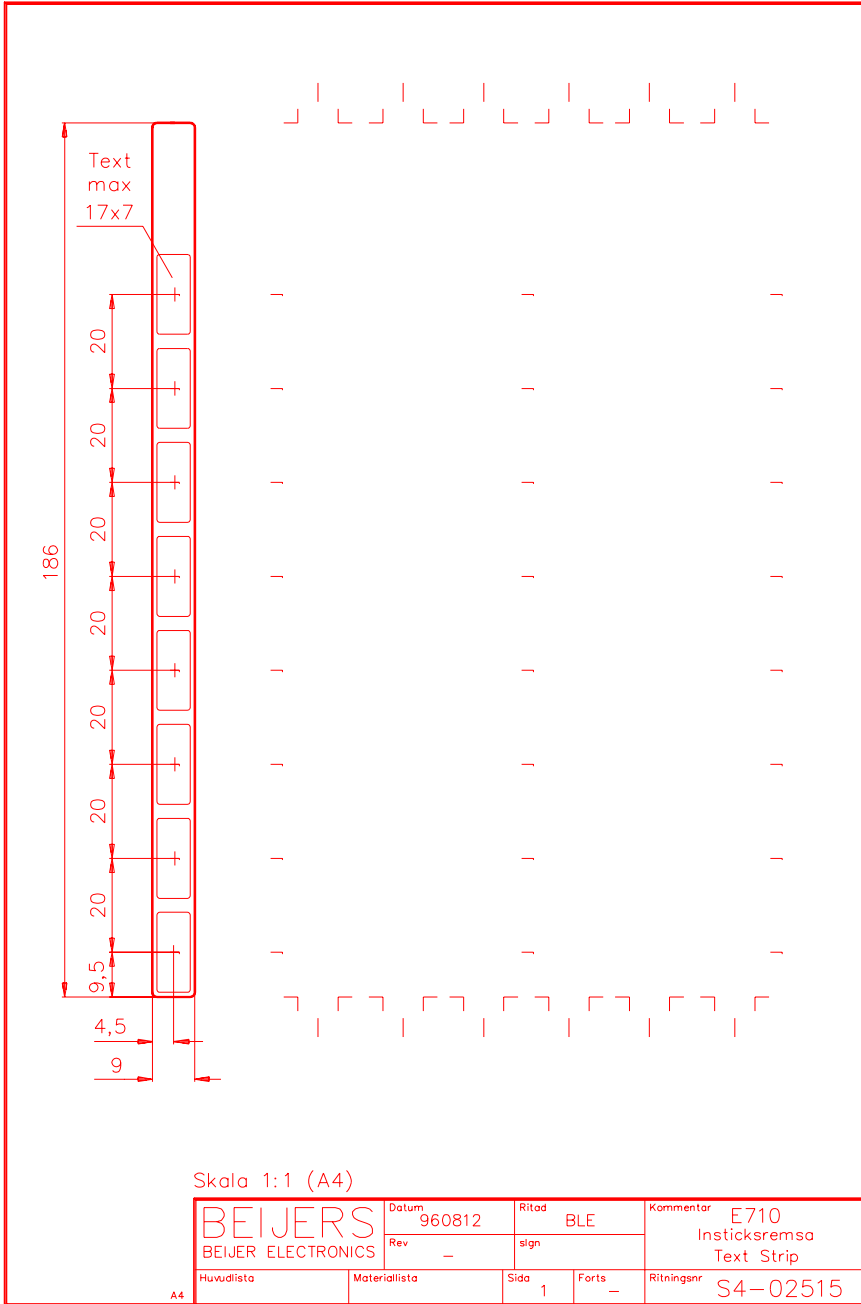

E710 Text strip



24.3 Character tables

Code page 437

The first characters, 0-127, are the same as in code page 850.

Ç 128 Coedil 00C7	É 144 Eacute 00C9	á 160 aacute 00E1	 176 blk14 2591	┌ 192 2514	⌌ 208 2568	α 224 alpha 03B1	≡ 240 equiv 2261
Û 129 uuml 00FC	æ 145 aelig 00E6	í 161 iacute 00ED	 177 blk12 2592	└ 193 2534	⌍ 209 2564	ß 225 szlig 00DF	± 241 plusmn 00B1
é 130 eacute 00E9	Æ 146 AElig 00C6	ó 162 oacute 00F3	 178 blk34 2593	┘ 194 252C	⌎ 210 2565	Γ 226 Gamma 0393	≥ 242 ge 2265
â 131 acirc 00E2	ô 147 ocirc 00F4	ú 163 uacute 00FA	179 2502	┘ 195 251C	⌏ 211 2559	Π 227 pi 03C0	≤ 243 le 2264
ä 132 auml 00E4	ö 148 ouml 00F6	ñ 164 ntilde 00F1	├ 180 2524	├ 196 2500	⌐ 212 2558	Σ 228 Sigma 03A3	┌ 244 2320
à 133 agrave 00E0	ò 149 ograve 00F2	Ñ 165 Ntilde 00D1	⇒ 181 2561	┘ 197 253C	⌑ 213 2552	σ 229 sigma 03C3	Ј 245 2321
â 134 aring 00E5	û 150 ucirc 00FB	ª 166 ordf 00AA	⌒ 182 2562	⌒ 198 255E	⌒ 214 2553	μ 230 micro 00B5	÷ 246 divide 00F7
ç 135 coedil 00E7	ù 151 ugrave 00F9	º 167 ordm 00BA	⌓ 183 2556	⌓ 199 255F	⌔ 215 256B	τ 231 tau 03C4	≈ 247 ap 2248
ê 136 ecirc 00EA	ÿ 152 yuml 00FF	¿ 168 iqust 00BF	⌔ 184 2555	⌕ 200 255A	⌕ 216 256A	Φ 232 PHgr 03A6	° 248 deg 00B0
ë 137 euml 00EB	ÿ 153 Ouml 00D6	┌ 169 2310	⌕ 185 2563	⌕ 201 2554	┘ 217 2518	Θ 233 Theta 0398	• 249 2219
è 138 egrave 00E8	Ü 154 Uuml 00DC	┐ 170 not 00AC	⌖ 186 2551	⌖ 202 2569	┘ 218 250C	Ω 234 Omega 03A9	· 250 middot 00B7
ï 139 iuml 00EF	ø 155 oslash 00F8	½ 171 frac12 00BD	⌗ 187 2557	⌗ 203 2566	■ 219 block 2588	δ 235 delta 03B4	√ 251 radic 221A
î 140 icirc 00EE	£ 156 pound 00A3	¼ 172 frac14 00BC	⌘ 188 255D	⌘ 204 2560	■ 220 lblock 2584	∞ 236 infin 221E	ⁿ 252 207F
ì 141 igrave 00EC	¥ 157 yen 00A5	¡ 173 iexcl 00A1	⌙ 189 255C	⌙ 205 2550	■ 221 258C	φ 237 phis 03C6	² 253 sup2 00B2
Ä 142 Auml 00C4	Ł 158 20A7	« 174 laquo 00AB	⌚ 190 255B	⌚ 206 256C	■ 222 2590	ε 238 epsi 03B5	■ 254 sqf 25A0
Å 143 Aring 00C5	ƒ 159 fnof 0192	» 175 raquo 00BB	┘ 191 2510	┘ 207 2567	■ 223 2580	∩ 239 cap 2229	255 nbsp 00A0



Code page 850

Character 0-127, the character 0-31 and 127 are used as control codes and cant be used in the application.

	000	▶ 016		0 048	@ 064	P 080	` 096	p 112
		rtrif 25B6	sp 0020	0030	commat 0040	0050	grave 0060	0070
☺	001	◀ 017	! 033	1 049	A 065	Q 081	a 097	q 113
263A		ltrif 25C0	excl 0021	0031	0041	0051	0061	0071
☹	002	↓ 018	" 034	2 050	B 066	R 082	b 098	r 114
263B		varr 2195	quot 0022	0032	0042	0052	0062	0072
♥	003	!! 019	# 035	3 051	C 067	S 083	c 099	s 115
hearts 2665		203C	num 0023	0033	0043	0053	0063	0073
♦	004	¶ 020	\$ 036	4 052	D 068	T 084	d 100	t 116
diams 2666		para 00B6	dollar 0024	0034	0044	0054	0064	0074
♣	005	§ 021	% 037	5 053	E 069	U 085	e 101	u 117
clubs 2663		sect 00A7	percent 0025	0035	0045	0055	0065	0075
♠	006	■ 022	& 038	6 054	F 070	V 086	f 102	v 118
spades 2660		25AC	amp 0026	0036	0046	0056	0066	0076
•	007	‡ 023	' 039	7 055	G 071	W 087	g 103	w 119
bull 2022		21A8	apos 0027	0037	0047	0057	0067	0077
◼	008	↑ 024	(040	8 056	H 072	X 088	h 104	x 120
25D8		uarr 2191	lpar 0028	0038	0048	0058	0068	0078
○	009	↓ 025) 041	9 057	I 073	Y 089	i 105	y 121
25C8		darr 2193	rpar 0029	0039	0049	0059	0069	0079
☉	010	→ 026	* 042	: 058	J 074	Z 090	j 106	z 122
25D9		rarr 2192	ast 002A	colon 003A	004A	005A	006A	007A
♂	011	← 027	+ 043	; 059	K 075	I 091	k 107	{ 123
male 2642		larr 2190	plus 002B	semi 003B	004B	lsqb 005B	006B	leub 007B
♀	012	└ 028	, 044	< 060	L 076	\ 092	l 108	124
female 2640		221F	comma 002C	lt 003C	004C	bsol 005C	006C	verbar 007C
☀	013	☀ 029	- 045	= 061	M 077] 093	m 109	} 125
sung 266A		harr 2194	hyphen 002D	equals 003D	004D	rsqb 005D	006D	reub 007D
♪	014	▲ 030	. 046	> 062	N 078	^ 094	n 110	~ 126
266B		utrif 25B2	period 002E	gt 003E	004E	circ 005E	006E	tilde 007E
☼	015	▼ 031	/ 047	? 063	O 079	_ 095	o 111	△ 127
263C		dtrif 25BC	sol 002F	quest 003F	004F	lowbar 005F	006F	2302

Code page 850

Character 128-255

Ç 128 Ccedil 00C7	É 144 Eacute 00C9	á 160 aacute 00E1	 176 blk14 2591	Ł 192 2514	ð 208 eth 00F0	Ó 224 Oacute 00D3	- 240 shy 00AD
ü 129 uuml 00FC	æ 145 aelig 00E6	í 161 iacute 00ED	 177 blk12 2592	⊥ 193 2534	Ð 209 ETH 00D0	ß 225 szlig 00DF	± 241 plusmn 00B1
é 130 eacute 00E9	Æ 146 AElig 00C6	ó 162 oacute 00F3	 178 blk34 2593	⊥ 194 252C	Ê 210 Ecirc 00CA	Ô 226 Ocirc 00D4	= 242 2017
â 131 acirc 00E2	ô 147 ucirc 00F4	ú 163 uacute 00FA	179 2502	⊥ 195 251C	Ë 211 Euml 00CB	Ö 227 Ograve 00D2	¾ 243 frac34 00BE
ã 132 auml 00E4	õ 148 ouml 00F6	ñ 164 ntilde 00F1	⊥ 180 2524	— 196 2500	È 212 Egrave 00C8	Ø 228 otilde 00F5	¶ 244 para 00B6
à 133 agrave 00E0	ò 149 ograve 00F2	Ñ 165 Ntilde 00D1	Á 181 Aacute 00C1	⊥ 197 253C	İ 213 inodot 0131	Õ 229 Otilde 00D5	§ 245 sect 00A7
å 134 aring 00E5	û 150 ucirc 00FB	ª 166 ordf 00AA	Â 182 Acirc 00C2	ã 198 atilde 00E3	Í 214 iacute 00CD	µ 230 micro 00B5	÷ 246 divide 00F7
ç 135 cedil 00E7	ù 151 ugrave 00F9	º 167 ordm 00BA	Ã 183 Agrave 00C0	Ä 199 Atilde 00C3	Î 215 icirc 00CE	þ 231 thorn 00FE	¸ 247 cedil 00B8
ê 136 ecirc 00EA	ÿ 152 yuml 00FF	¿ 168 iquest 00BF	© 184 copy 00A9	Ł 200 255A	Ï 216 iuml 00CF	Þ 232 THORN 00DE	° 248 deg 00B0
ë 137 euml 00EB	Û 153 Uuml 00D6	® 169 reg 00AE	≡ 185 2563	⌌ 201 2554	⌋ 217 2518	Ú 233 Uacute 00DA	” 249 uml 00AB
è 138 egrave 00E8	Ü 154 Uuml 00DC	¬ 170 not 00AC	≡ 186 2551	≡ 202 2569	⌌ 218 250C	Û 234 Ucirc 00DB	· 250 middot 00B7
ï 139 iuml 00EF	ø 155 oslash 00F8	½ 171 frac12 00BD	⌌ 187 2557	≡ 203 2566	■ 219 block 2588	Ù 235 Ugrave 00D9	¹ 251 sup1 00B9
î 140 icirc 00EE	ƒ 156 pound 00A3	¼ 172 frac14 00BC	⌌ 188 255D	≡ 204 2560	■ 220 hblk 2584	Ý 236 yacute 00FD	³ 252 sup3 00B3
ì 141 igrave 00EC	Ø 157 Oslash 00D8	¡ 173 texol 00A1	¢ 189 cent 00A2	≡ 205 2550	¡ 221 brvbar 00A6	Ÿ 237 Yacute 00DD	² 253 sup2 00B2
Ä 142 Auml 00C4	× 158 times 00D7	« 174 laquo 00AB	¥ 190 yen 00A5	≡ 206 256C	ì 222 igrave 00CC	˘ 238 macr 00AF	■ 254 sqf 25A0
Å 143 Aring 00C5	ƒ 159 fnof 0192	» 175 raquo 00BB	⌌ 191 2510	⌌ 207 256C	■ 223 uhblk 2580	˘ 239 acute 00B4	255 nbsp 00A0

Code page 866

А	Б	В	Г	Д	Е	Ж	З	И	Й	К	Л	М	Н	О	П
128	129	130	131	132	133	134	135	136	137	138	139	140	141	142	143
Р	С	Т	У	Ф	Х	Ц	Ч	Ш	Щ	Ъ	Ы	Ь	Э	Ю	Я
144	145	146	147	148	149	150	151	152	153	154	155	156	157	158	159
а	б	в	г	д	е	ж	з	и	й	к	л	м	н	о	п
160	161	162	163	164	165	166	167	168	169	170	171	172	173	174	175
␣	␣	␣		┆	┆		┆	┆		┆		┆	┆	┆	┆
176	177	178	179	180	181	182	183	184	185	186	187	188	189	190	191
␣	␣	␣	┆	┆	┆	┆	┆	┆	┆	┆	┆	┆	┆	┆	┆
192	193	194	195	196	197	198	199	200	201	202	203	204	205	206	207
␣	␣	␣	┆	┆	┆	┆	┆	┆	┆	┆	■	■	■	■	■
208	209	210	211	212	213	214	215	216	217	218	219	220	221	222	223
р	с	т	у	ф	х	ц	ч	ш	щ	ъ	ы	ь	э	ю	я
224	225	226	227	228	229	230	231	232	233	234	235	236	237	238	239
Ё	ё	Є	є	Ӏ	Ӂ	ӂ	Ӄ	°	•	•	√	№	π	■	nbsp
240	241	242	243	244	245	246	247	248	249	250	251	252	253	254	255

Code page for E100

		Higher 4-bit (D4 to D7) of Character Code (Hexadecimal)																	
		0	1	2	3	4	5	6	7	8	9	A	B	C	D	E	F		
Lower 4-bit (D0 to D3) of Character Code (Hexadecimal)	0	CG RAM (1)	!	0	1	2	3	4	5	6	7	8	9	A	B	C	D	E	F
	1	CG RAM (2)	!	!	2	3	4	5	6	7	8	9	A	B	C	D	E	F	
	2	CG RAM (3)	!	2	3	4	5	6	7	8	9	A	B	C	D	E	F		
	3	CG RAM (4)	!	2	3	4	5	6	7	8	9	A	B	C	D	E	F		
	4	CG RAM (5)	!	2	3	4	5	6	7	8	9	A	B	C	D	E	F		
	5	CG RAM (6)	!	2	3	4	5	6	7	8	9	A	B	C	D	E	F		
	6	CG RAM (7)	!	2	3	4	5	6	7	8	9	A	B	C	D	E	F		
	7	CG RAM (8)	!	2	3	4	5	6	7	8	9	A	B	C	D	E	F		
	8	CG RAM (1)	!	2	3	4	5	6	7	8	9	A	B	C	D	E	F		
	9	CG RAM (2)	!	2	3	4	5	6	7	8	9	A	B	C	D	E	F		
	A	CG RAM (3)	!	2	3	4	5	6	7	8	9	A	B	C	D	E	F		
	B	CG RAM (4)	!	2	3	4	5	6	7	8	9	A	B	C	D	E	F		
	C	CG RAM (5)	!	2	3	4	5	6	7	8	9	A	B	C	D	E	F		
	D	CG RAM (6)	!	2	3	4	5	6	7	8	9	A	B	C	D	E	F		
	E	CG RAM (7)	!	2	3	4	5	6	7	8	9	A	B	C	D	E	F		

Code page for E200

Higher bit Lower bit	0000	0010	0011	0100	0101	0110	0111	1010	1011	1100	1101	1110	1111
xxx0000	CG RAM (1)		0	A	P	'	F	-	9	E	o	p	
	(2)	!	1	A	a	a	a	7	4	a	a		
xxx0010	(3)	"	2	B	B	b	b	4	v	x	p	a	
	(4)	#	3	C	C	c	c	0	T	E	e	w	
xxx0100	(5)	\$	4	D	D	d	d	\	I	F	p	a	
	(6)	%	5	E	E	e	e	.	+	1	e	u	
xxx0110	(7)	&	6	F	F	f	f	o	h	1	e	a	
	(8)	'	7	G	G	g	g	7	x	7	g	a	
xxx1000	(1)	(8	H	H	h	h	4	0	*	v	r	x
	(2))	9	I	I	i	i	4	o	7	u	r	y
xxx1010	(3)	*	:	J	J	j	j	z	z	o	v	i	f
	(4)	+	;	K	K	k	k	1	7	e	o	*	a
xxx1100	(5)	,	<	L	L	l	l	1	7	o	7	o	a
	(6)	-	=	M	M	m	m	1	z	1	o	t	+
xxx1110	(7)	.	>	N	N	n	n	+	a	t	t	'	n
	(8)	/	?	O	O	o	o	4	w	v	7	o	■

25 Appendix

Error messages in the terminals when communicating with MELSEC PLC systems

FX, ACPU and C24

Error code	Description
Comm Error	Communication error.
File Reg Err xxxx	An object tries to read a file register not configured in the parameters in the PLC system.
Illegal dev [x]	Trying to read an not valid device type (D, X, Y...). Only C24.

QCPU driver

Error code	Description
Comm Error xxxx	Communication error, see the table below.
SYSTEM ERROR Comm Error	Communication error during start-up.

Item	Content	Reply status
Common Errors	Sum check error (periphery only)	4000H
	Cannot handle RT	4001H
	Cannot handle SRT	4002H
	Impossible global request command	4003H
	Command not usable during system protect	4004H
	Data range larger than buffer size	4005H
	No password release	4006H
	CID differing from CPU data	4007H
Device setting	Cannot handle device name	1030H
	Device range over	4031H
	Cannot handle device modification	4032H

Item	Content	Reply status
	No random write possible on the desinated Y because it is used by the system	4033H
	Improper device	4034H
Protect	Hardware protection active	4050H
	No execution possible because memory protect switch is ON	4051H
Others	Data error	4080H

Index

A

Acknowledge notify, 153
 Acknowledge required, 154
 Alarm banner object, 91
 Alarm editor, 65
 Alarm group, 151
 Alarm handling
 Define alarm group, 151
 Define alarm list, 154
 Define alarm message, 153
 Graphic alarm page, 157
 Maneuvering, 156
 Alarm handling, 151
 Alarm history, 154
 Alarm info. block, 154, 157
 Alarm list erase, 155
 Alarm list size, 155
 Alarm message, 153
 Alarm remote acknowledge, 153
 Alarm settings, 80
 Alarm summary notify, 152
 Alarm symbol, 155
 Align, 52
 Alpha/numerical keyboard, 16
 Analog clock object, 92
 Analog fill object, 93
 Analog objects, 89
 Analog signals, 32
 Append, 65
 Application, 25
 Arrow keys, 18
 ASCII object, 94

B

Background block, 43, 85
 Backlight signal, 73, 155

Bar graph object, 95, 130

Block

 Create, 39
 Edit, 67
 Programming, 46

Block header, 46

Block jump, 40

Block list, 67

Block Manager menu, 84

Block Manager, 39

 Settings, 45

Block, 1, 30

Built-in function keys, 18

Buzzer, 73

C

Clock

 Analog, 92

 Digital, 98

Clompetition signal, 42

Color scheme

 Change/create, 37

Colors, 87

Command line, 75

Communication error, 15

Communication, 15

Connect to a printer, 172

Contrast settings, 13

Controller I/O 70

Coordinates, 8

Copy graphics, 56

Country settings, 76

Create insertable strip, 46

Create object, 50

Create project, 35

Create series, 55

Crossreference, 64

 Presentation, 64

D

Date format, 77
 Date object, 131
 Daylight saving, 78
 Define block header, 41
 Diagram object, 96
 Digital clock object, 98
 Digital objects, 89
 Digital signals, 31
 Digital symbol object, 101
 Digital text object, 102, 132
 Display signal, 42

E

Edit menu, 67
 Editing graphic objects, 14
 Erase memory, 12
 Error message, 15
 Expansion card, 271
 External keyboard, 18

F

File menu, 66
 Filled object
 Digital, 99
 Function keys, 65, 263
 Define, 263
 Global, 263
 Jump to block, 270
 Local, 263
 Functions menu, 70

G

Gain, 87, 127
 Graphic alarm page, 157
 Graphic block printout, 173
 Graphic blocks, 29
 Graphic objects

Alarm banner, 91
 Analog clock, 92
 Analog fill, 93
 Analog, 89
 ASCII object, 94
 Bar graph, 95
 Diagram, 96
 Digital clock, 98
 Digital symbol, 101
 Digital text, 102
 Digital, 89
 Filled object, 99
 Jump, 103, 133
 Maneuvering, 118
 Multiple choice, 105
 Multisymbol, 106
 Numeric table, 108
 Numeric, 107
 Slide, 110
 Speedometer, 111
 Static objects, 88
 Touch key, 114
 Trend, 115
 VU meter, 117
 Graphicblock editor, 47
 3D-Controls, 51
 Create object, 50
 Create series, 55
 Cursor, 48, 49
 Draft Move & Size, 51
 Group object, 54
 Keys, 48
 Mouse, 48
 Open, 47
 Place object, 52
 Recommendations, 51
 Static graphics, 51
 Toolbox, 49
 Ungroup object, 54
 Grid, 50

Group object, 54

H

Help line, 14

Help menu, 86

Historical trends, 139

 Calculate, 140

 Run-time mode, 140

I

I/O change, 62

I/O Crossreference, 64

IFC MC, 271

IFC PBDP, 271

install driver, 36, 37

Information page, 21

Insert, 65

Insertable strip, 46

Internet, 36

J

Joystick function, 22

Jump object, 103, 133

Jump to block, 270

K

Key beep, 79

Key delay time, 79

Key repeat, 79

Key sequences, 19

Keyboard

 Alpha/numerical, 16

Keyfield, 44

L

Language, 76

LEDs

 Define, 261

LEDs, 65, 261

Levels, 30

Library index register, 74

M

MAC Programmer+, 7

 Block Manager menu, 84

 Edit menu, 67

 File menu, 66

 Functions menu, 70

 Help menu, 86

 Install, 7

 Setup menu, 72

 System requirements, 7

 Trasfer menu, 84

 View menu, 67

 Window menu, 85

Maneuver objects

 Analog objects, 119, 137

 Digital objects, 118, 137

Maneuverable objects, 118

Maneuvering graphic blocks, 118

Maneuvering textblocks, 137

Menu bar, 8

Menu structure, 29

Message library, 147

Message object, 104, 134

Method for programming, 25

Multiple choice object, 105, 135

Multisymbol object, 106

N

Name list, 68
National characters, 16
Network communication via IFC
ET, 211
No protocol mode, 189
Numeric objects, 107
Numeric table object, 108
Numeric values, 17

O

Offset, 87, 127
OGC, 88, 127
Operation mode
 PROG, 13
 RUN, 15
 SETUP, 12
Operation modes
 Switch, 11
Operation modes, 11
Operator's pictures, 29

P

Passwords
 Change, 169
 Define, 167
 Logging in, 169
 Security levels, 167
Passwords, 65, 167
PLC system, 36
Popup keyboard, 121
PREV, 18
Print alarms, 154
Print signal, 42
Printer
 Connection, 172
Printer settings, 82, 174
Profibus-DP, 271
Programming mode, 13

Project

Close, 66
Create, 35, 66
Open, 66
Programming, 25
Save, 66
Transfer, 84, 273

R

Real-time clock
 Set, 20
Real-time trends, Trend,
 Reall-time trends, 141
Recipe
 Calculate, 160
 Create, 161
 Erase, 162
 Files, 159
 HMI Tools, 162
 Transfer, 161
 Via the PLC-program, 164
Recipe, 159
Report print-outs
 Define, 173
 Port parameters, 175
 Printer settings, 174
Report print-outs, 171
Reserved characters, 17, 58
RS-232, 81
RS-422, 81
Run-time mode, 15

S

Scaling, 87, 127
Screen save time, 79
Security level
 Define, 167
 Password, 167
Security level, 18, 167
Select maneuverable objects, 118
Serial network communication, 216
Setup menu, 72
Setup mode, 12
Show terminal, 45
Signal format, 33
Slide object, 110
Speedometer object, 111
Static graphics, 51
Static objects, 88
Status bar, 8
Switch between modes, 11
Switch between PROG/SETUP, 11
Switch between RUN/PROG, 11
Switch between RUN/SETUP, 12
Symbol handling, 67
Symbol manager,
 Create, 60
 Delete, 61
 Duplicate, 61
 Edit, 60
 Export, 59
 Import, 59
 More, 61
Symbols,
 Create, 56
System blocks, 30
System program
 Down-loading, 9
System signals, 72

T

Technical data, 285
Template, 41, 44
Terminal as communication interface, 189
Terminal options, 79
Test project, 66
Text objects
 Analog object, 129
 Bar graph object, 130
 Date/time object, 131
 Digital text, 132
 Dynamic objects, 128
 Message, 134
 Multiple choice object, 135
 Text object, 136
Textblock editor,
 Define, 58
 Dynamic object, 58
 Keys, 57
 Mouse, 57
 Open, 57
 Static text, 58
 Toolbox, 58
Textblock printout, 172
Textblocks, 29
 Maneuvering, 137
Textobjects
 Message, 104
Tile, 53
Time channels
 Define, 177
 Maneuvering, 178
Time channels, 65, 177
Time control, 177
Time format, 77
Time object, 131
Tool box, 46
Touch, 114

Transfer

Project, 273

Settings, 274

Transfer menu, 84

Trend object, 115

Trend, 139

Define trend objects, 142

Historical trend, 139

History, 120

HMI Tools, 144

Real-time trend, 139

Transferring trend data, 144

Trend files, 144

Trend object, 139

U

Undo, 67

Ungroup object, 54

Update drivers, 36, 37

Update, 65

V

View menu, 67

VU-meter object, 117

W

Watch-dog, 15

Window menu, 85

Working area, 46